

# REGIONE SICILIANA

## CONSORZIO AMBITO TERRITORIALE OTTIMALE IDRICO DI AGRIGENTO



### GESTORE DEL SISTEMA IDRICO INTEGRATO AMBITO TERRITORIALE OTTIMALE DI AGRIGENTO

L'AMMINISTRATORE DELEGATO

Subentro a Girgenti Acque SpA

.....

### PROGETTO ESECUTIVO - PRIMO STRALCIO

Opere di ristrutturazione ed automazione per ottimizzazione  
rete idrica Comune di Agrigento

ALLEGATO N°

18.15.3

TITOLO ELABORATO

Telecontrollo  
Schemi elettrici e cablaggi periferiche  
Tipologico Nodo Serbatoio

Nome file: 18.15.3 Tipologico Nodo Serbatoio.dwg

Scala:

Visti ed approvazioni:

CUP: C43H11000140004

SERVIZI  
INGEGNERIA  
**delta**  
ingegneria

**Delta Ingegneria s.r.l.**

I DIRETTORI TECNICI:  
Ing. Maurizio Carlino  
Ing. Nicola D'Alessandro



Arch. Carmelo Carlino  
Ing. Domenico D'Alessandro  
Ing. Alfonso Collura  
Ing. Desiderio Carlino  
Geol. Massimo Carlino  
Ing. Manuela Carlino  
Ing. Martina Carlino

REV.	DESCRIZIONE	DATA	VERIFICATO	CONTROLLATO	APPROVATO



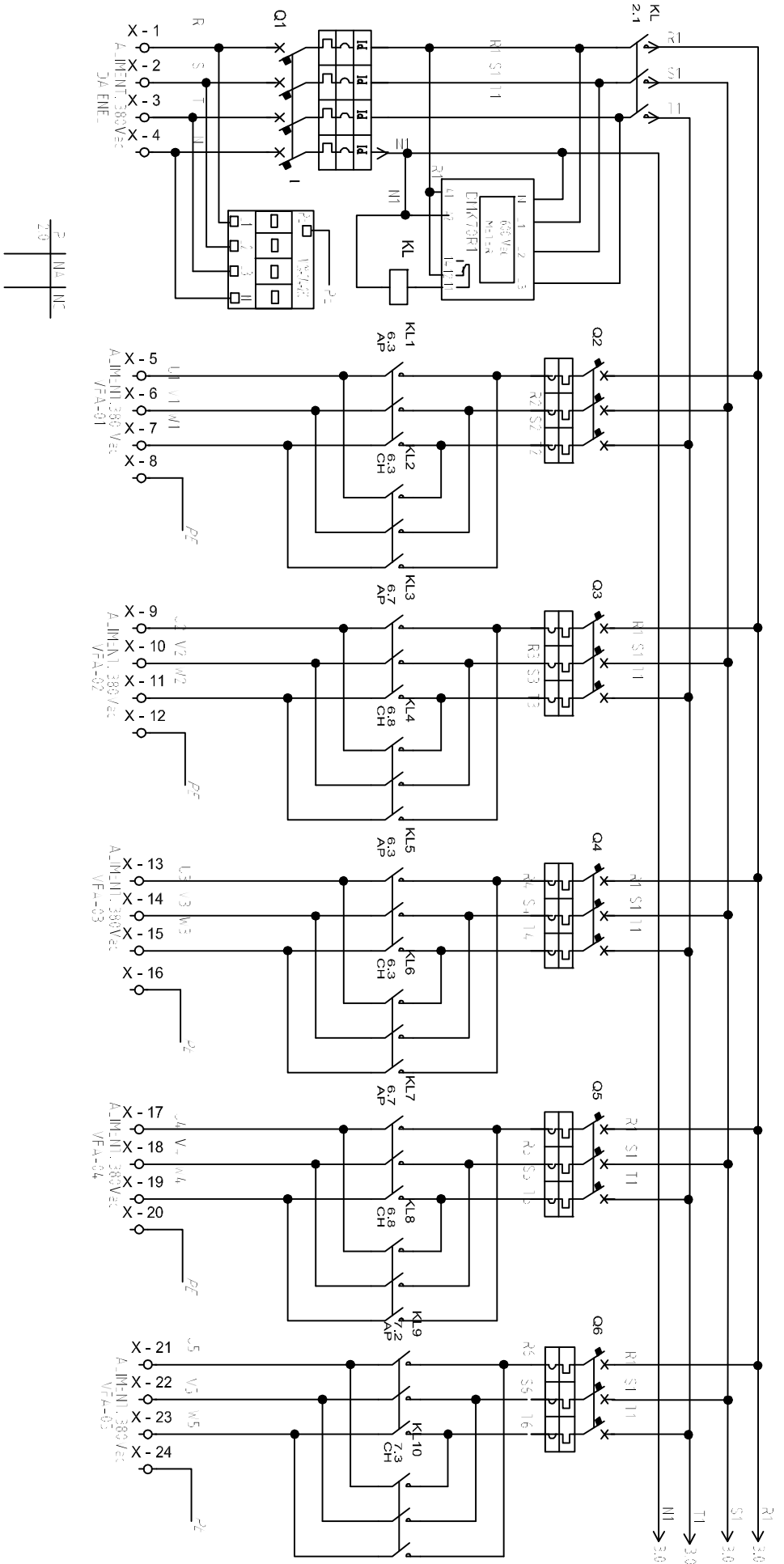

REV	MODIFICA	PROGETTO: UNITA PERIFERICA TIPO SERBATOIO	FOGLIO 2
DATA	FIRMA	COMMESSA:	DI 35
		TITOLO:	DIS: 1
		DATA:	3

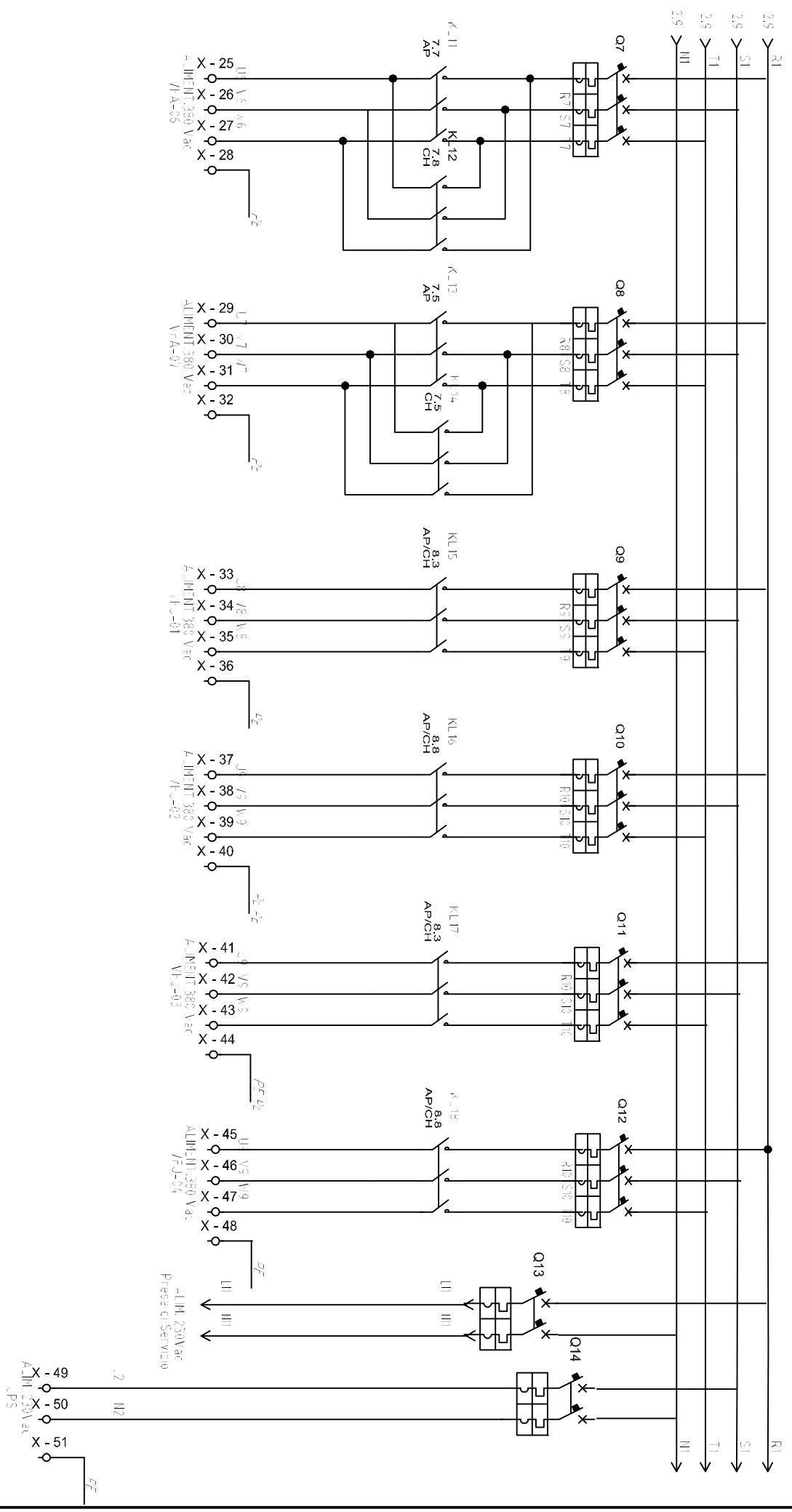

REVISIONE	MODIFICA	PROGETTO: UNITA' PERIFERICA TIPO SERBATOIO	FOGLIO 3
		COMMESSA:	DI 35
		CLIENTE:	
		TITOLO:	
DATA	FIRMA	DIS:	DATA:

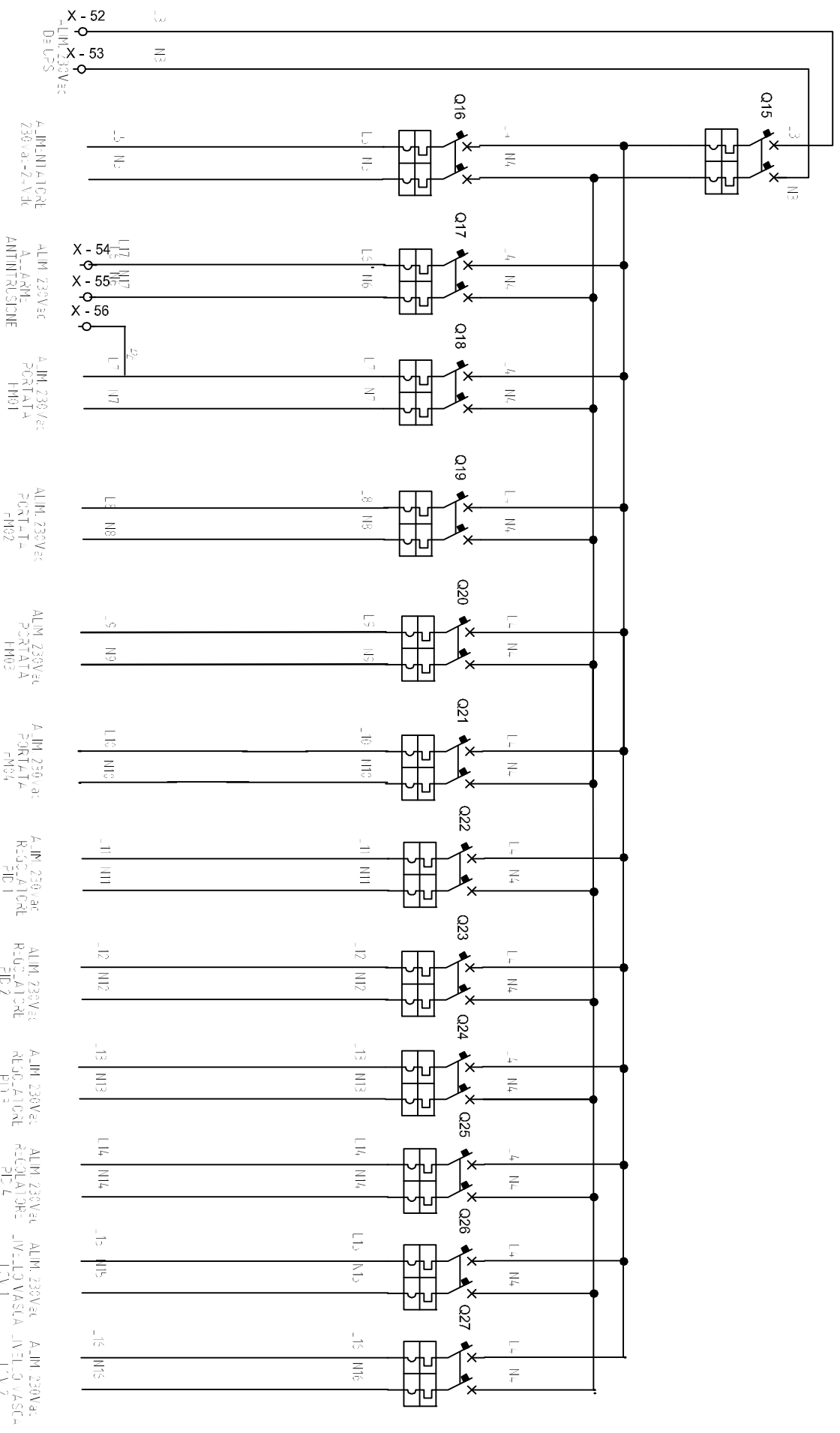

REVISIONE	MODIFICA	PROGETTO: UNITA' PERIFERICA TIPO SERBATOIO	FOGLIO 4
		COMMESSA:	DI 35
DATA	FIRMA	CLIENTE:	
		TITOLO:	
		DIS.:	DATA:
			3 < > 5

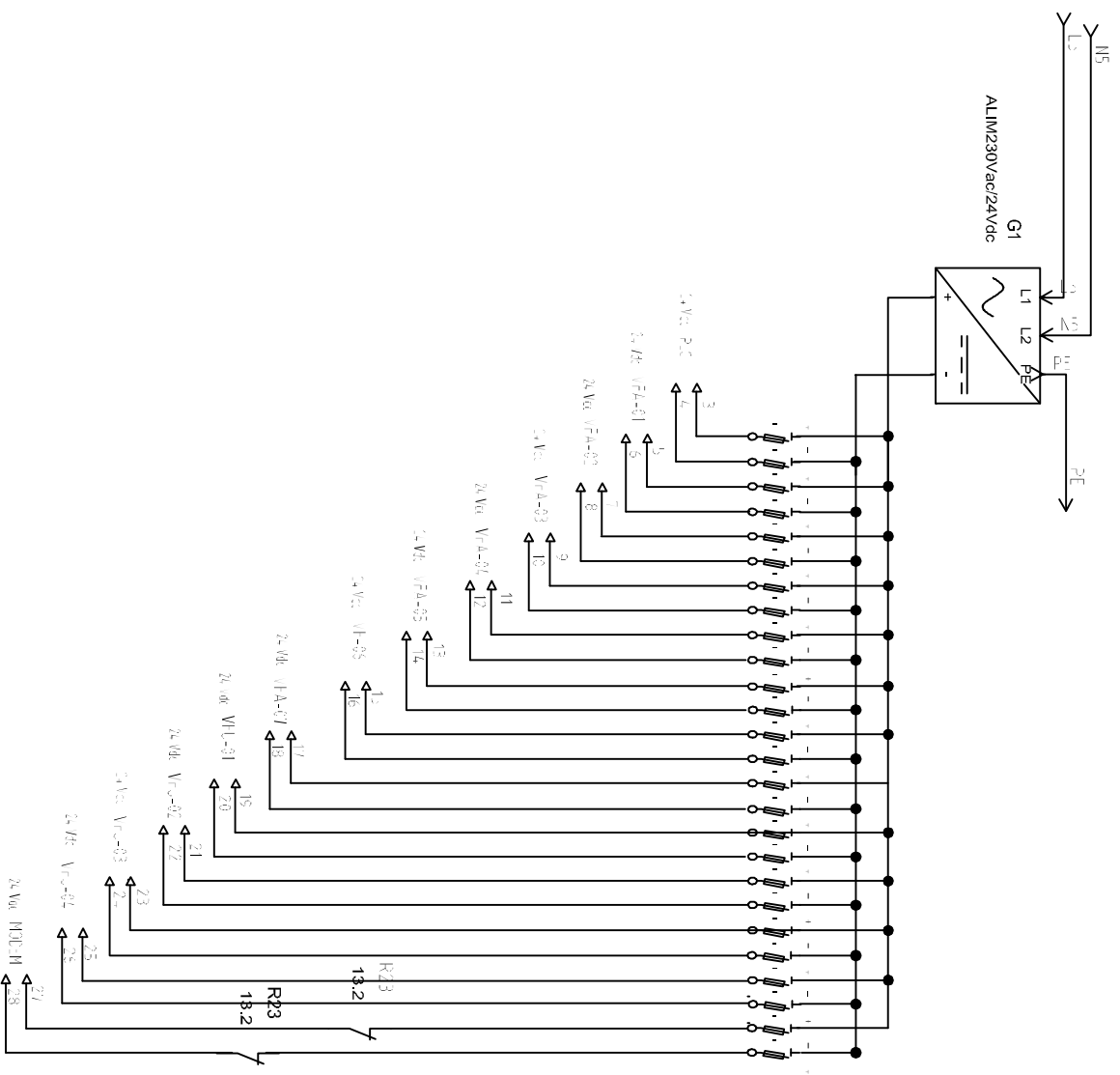

REVISIONE MODIFICA

DATA FIRMA

PROGETTO: UNITA PERIFERICA TIPO SERBATOIO

COMMESSA:

CLIENTE:

TITOLO:

DIS: DATA:

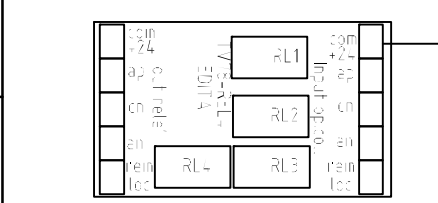
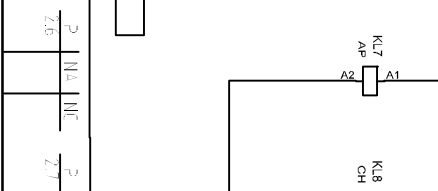
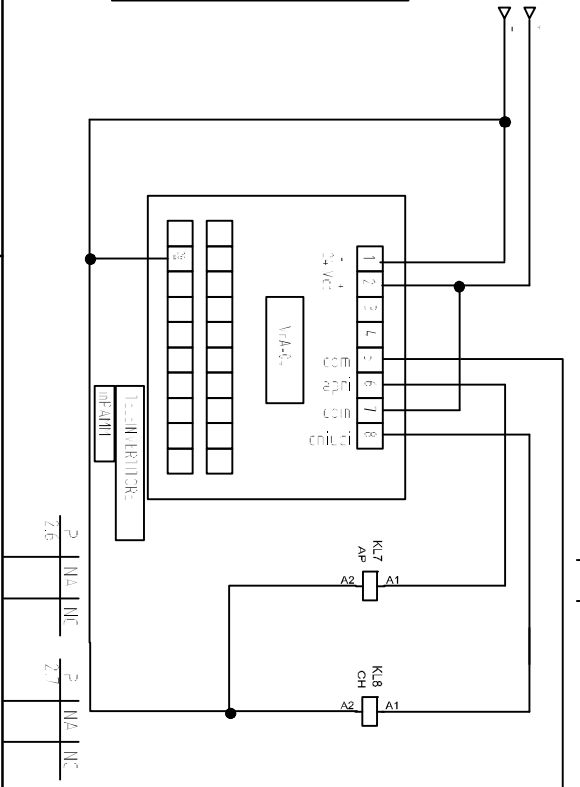
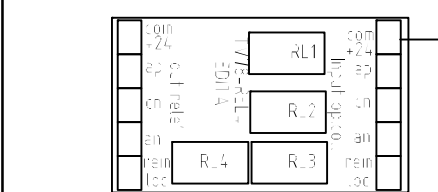
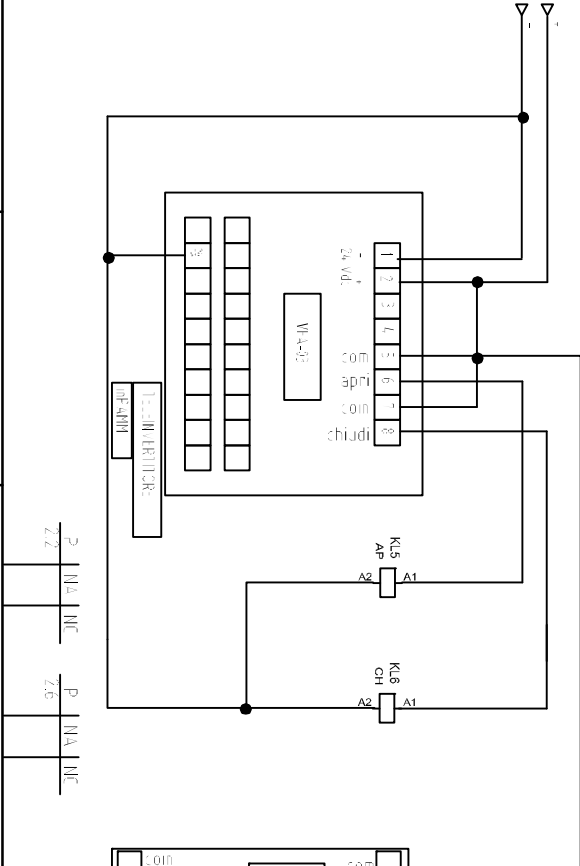
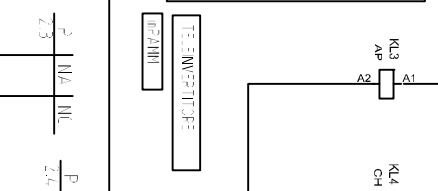
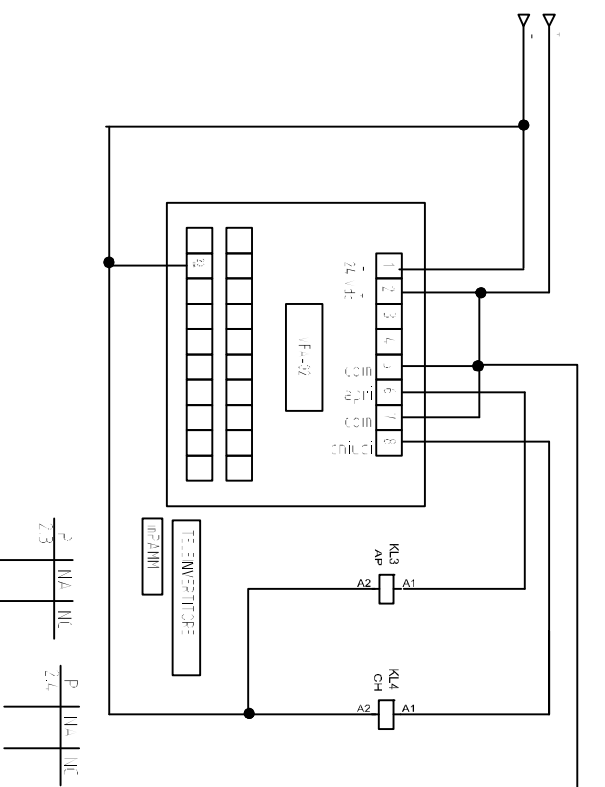
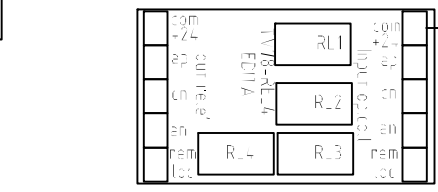
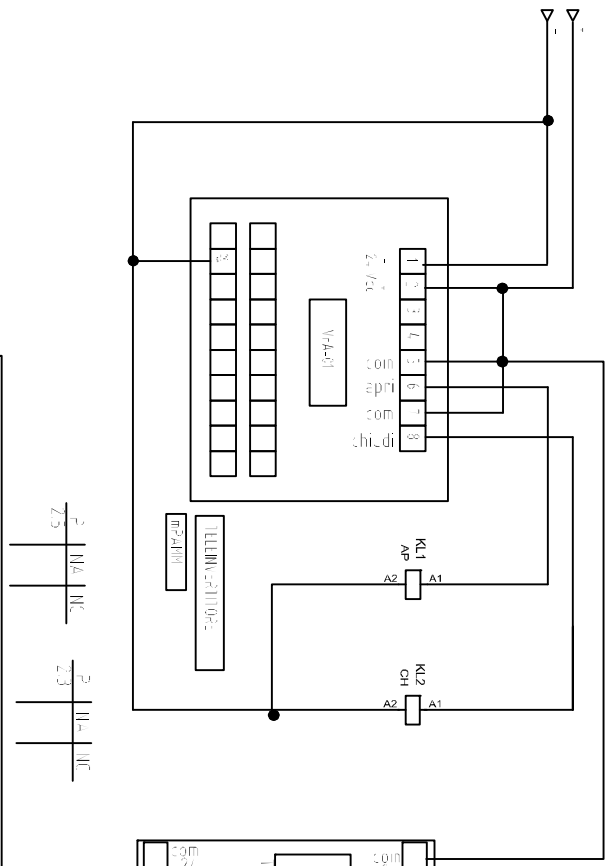

REVISIONE MODIFICA PROGETTO: UNITA' PERIFERICA TIPO SERBATOIO

COMMESSA: CLIENTE: TIPOLO: DIS: DATA: FOGLIO 6 DI 35

DATA FIRMA

5 6 7

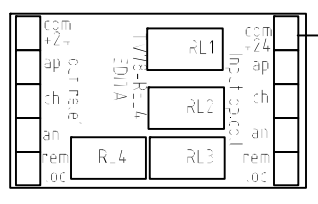
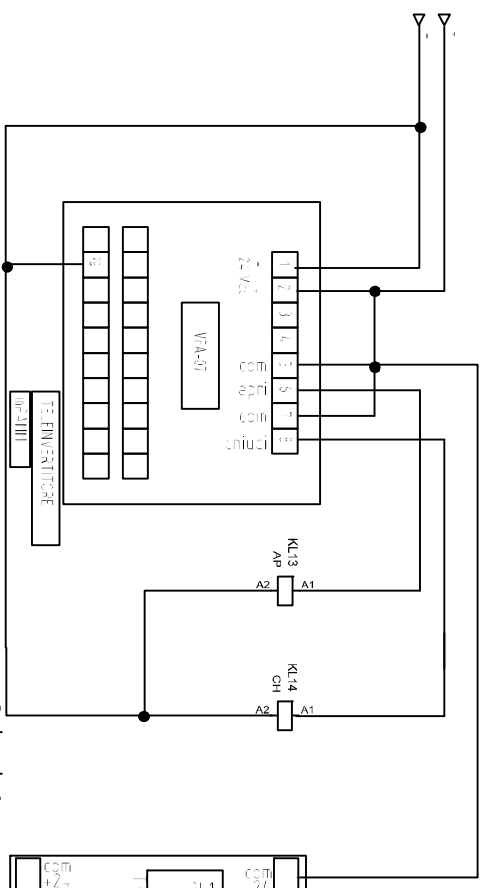
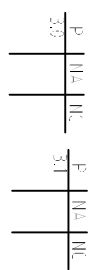
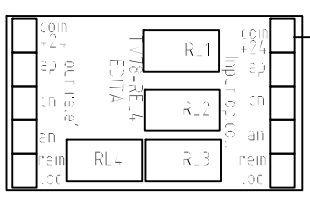
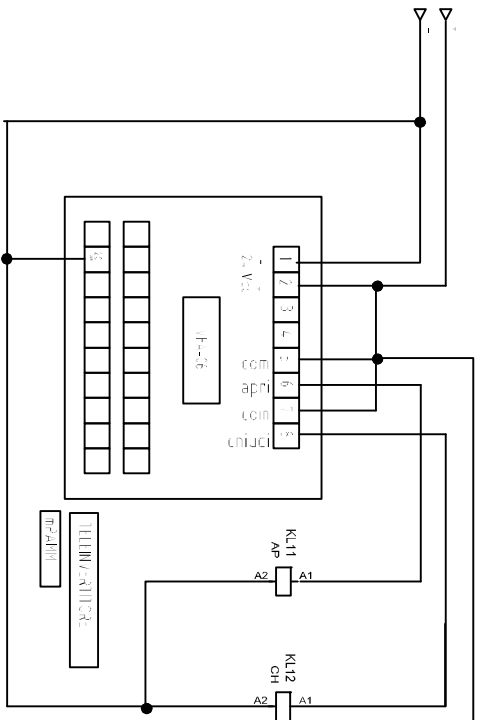
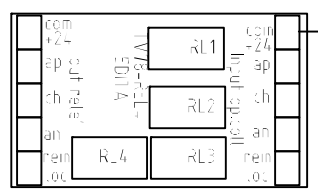
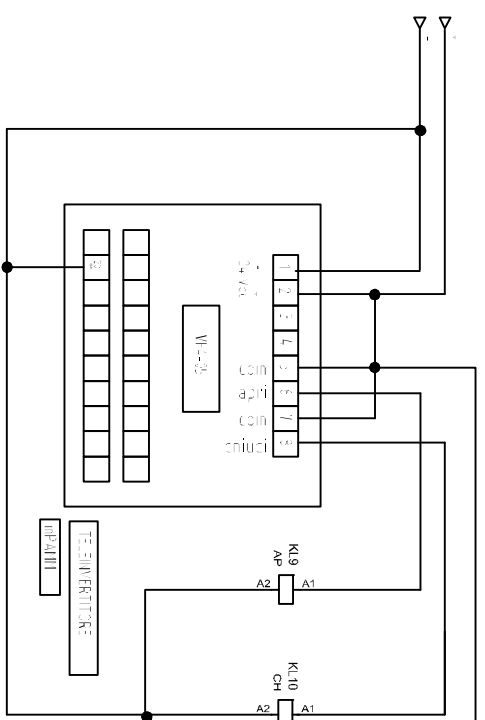

REVISIONE

MODIFICA

PROGETTO: UNITA' PERIFERICA TIPO SERBATOIO

COMMESSA:

FOGLIO 7

CLIENTE:

DI 35

TITOLO:

6 <> 8

DATA

FIRMA

DIS:

DATA:



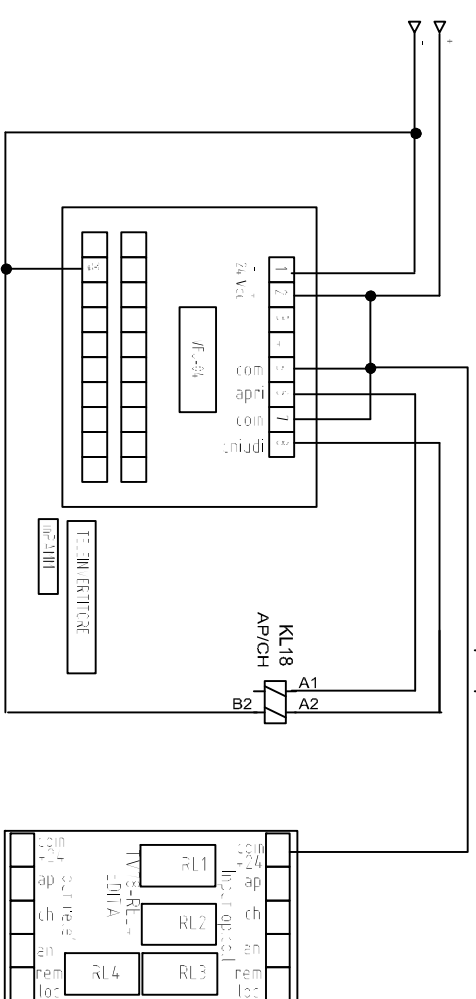
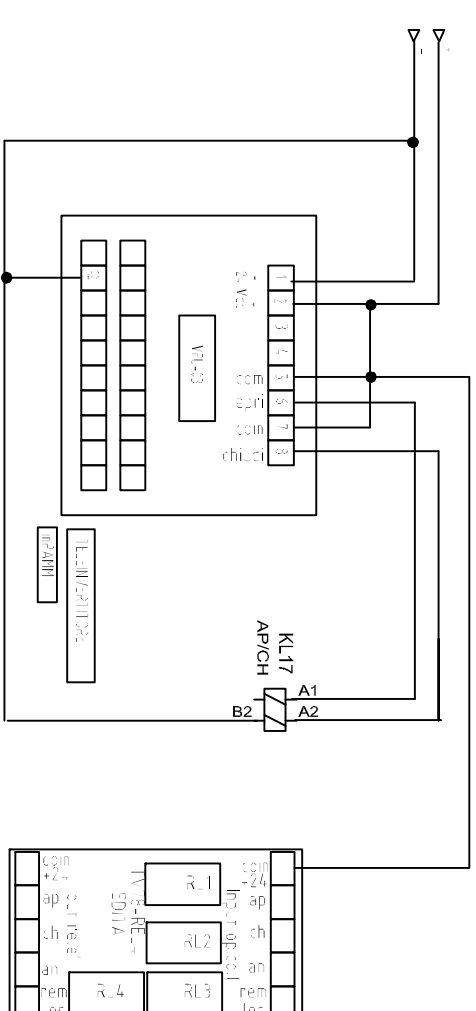
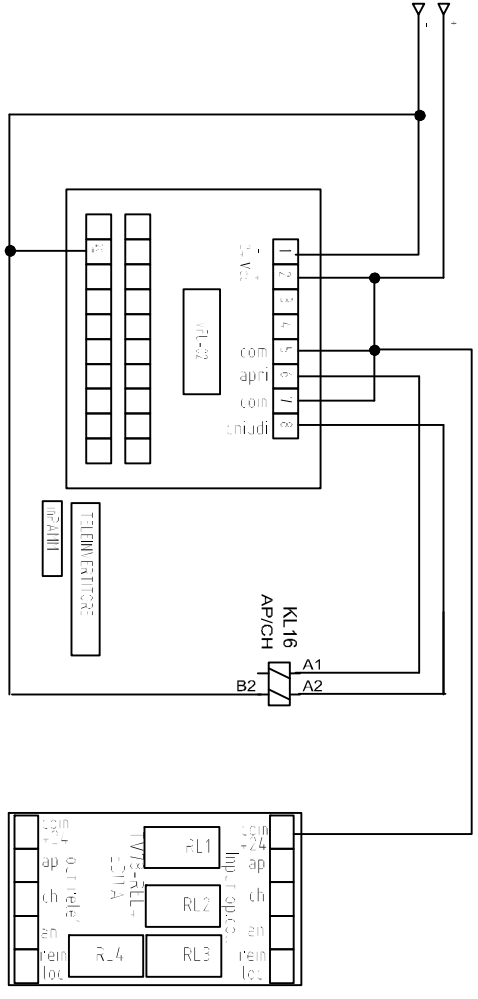
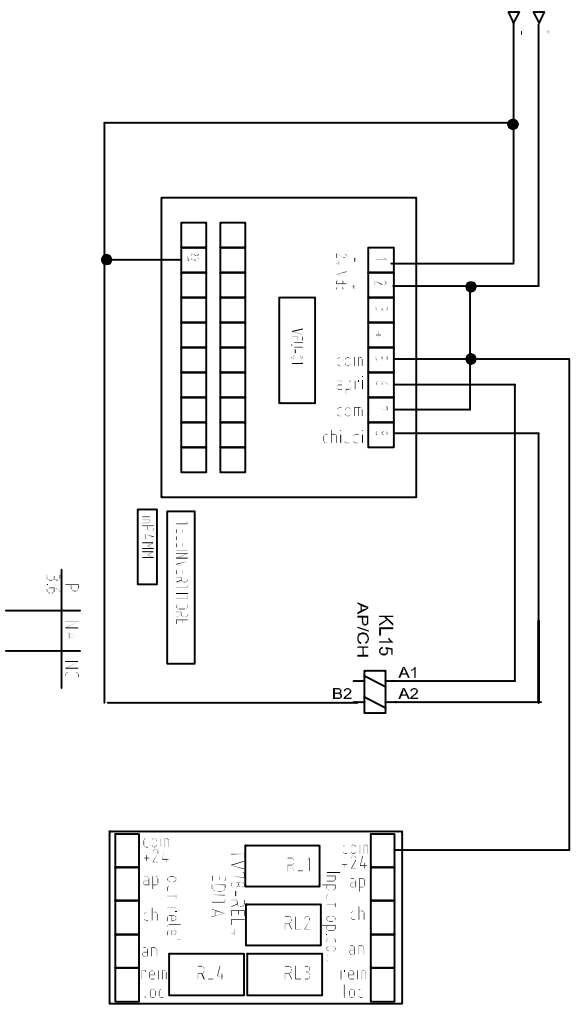

REVISIONE	MODIFICA	PROGETTO: UNITA' PERIFERICA TIPO SERBATOIO	FOGLIO 8
		COMMESSA:	DI 35
	FIRMA	CLIENTE:	
		TITOLO:	
DATA		DIS:	DATA:
			7 9

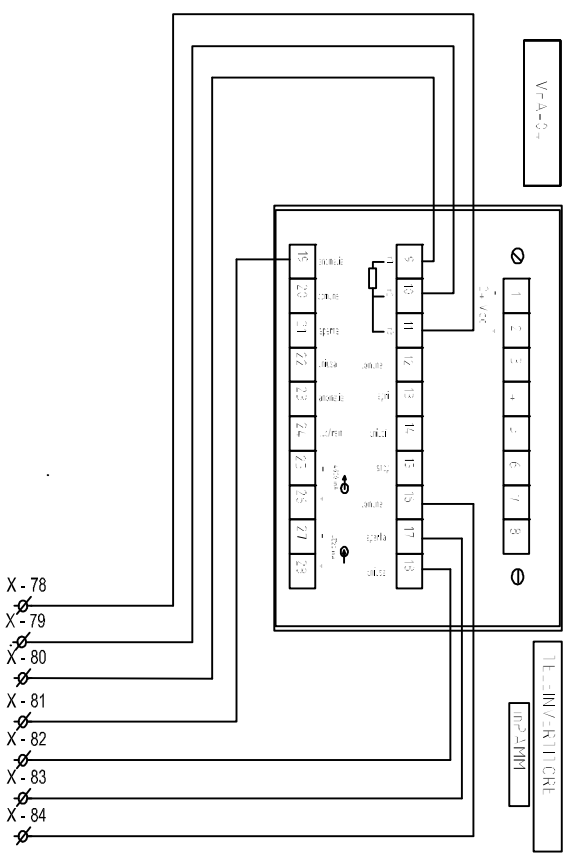
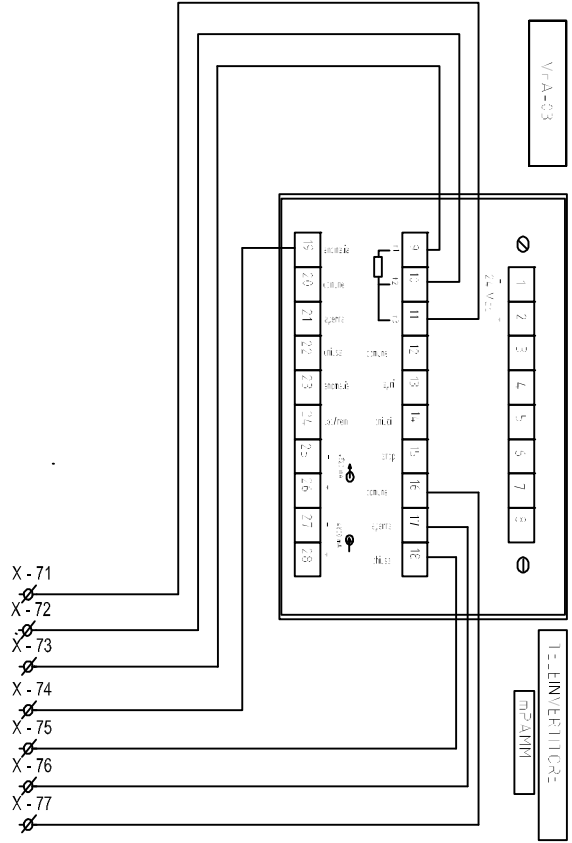
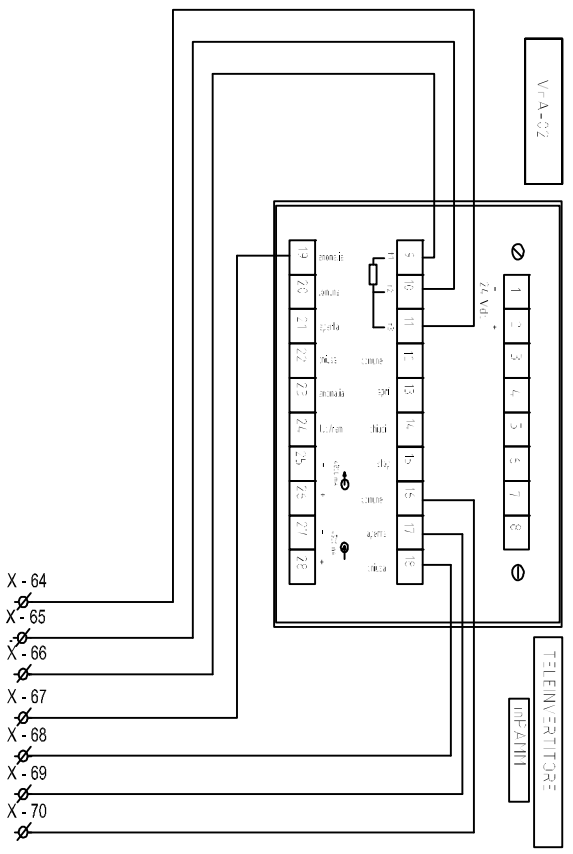
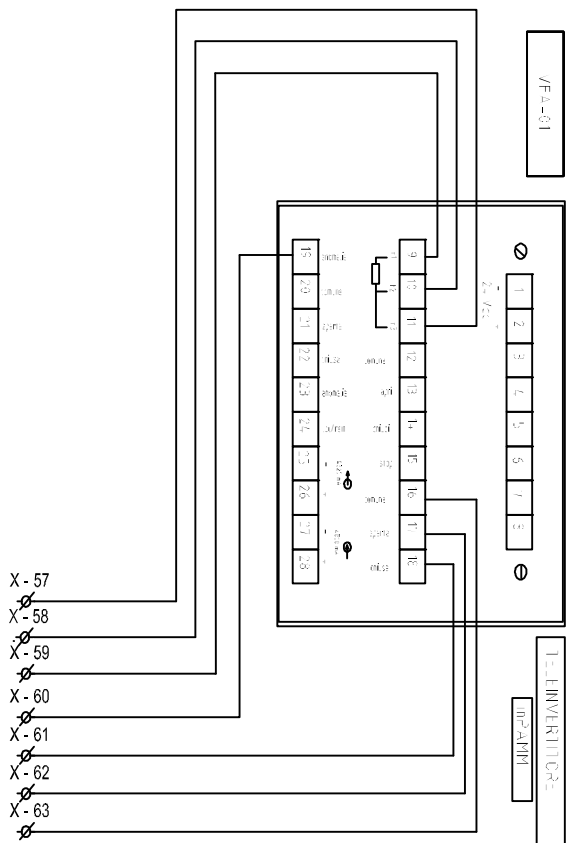

REVISIONE	MODIFICA	PROGETTO: UNITA' PERIFERICA TIPO SERBATOIO	FOGLIO 9
		COMMESSA:	DI 35
		CIENTE:	
		TITOLO:	
DATA	FIRMA	DIS.:	DATA:

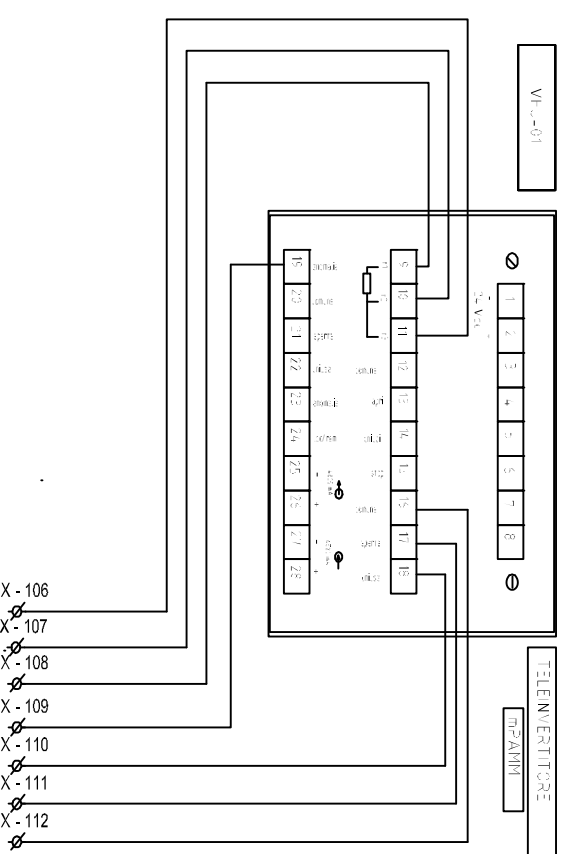
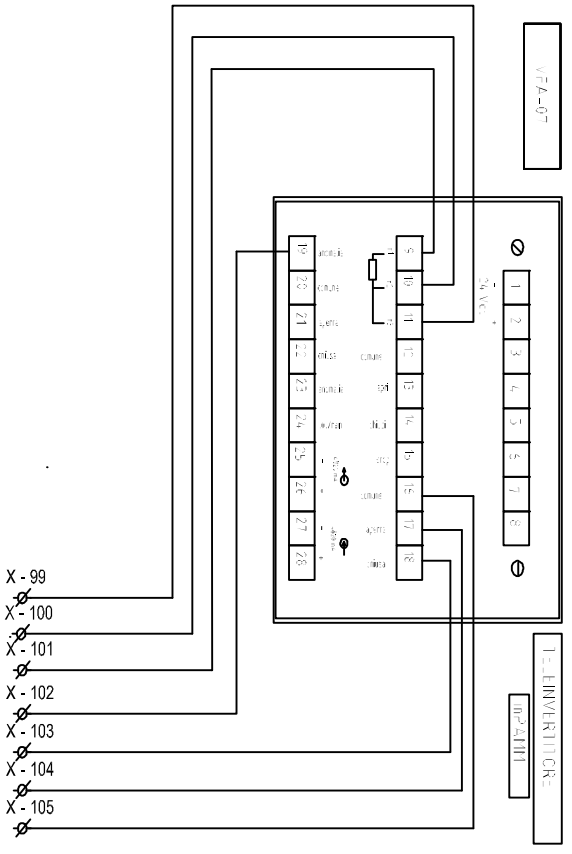
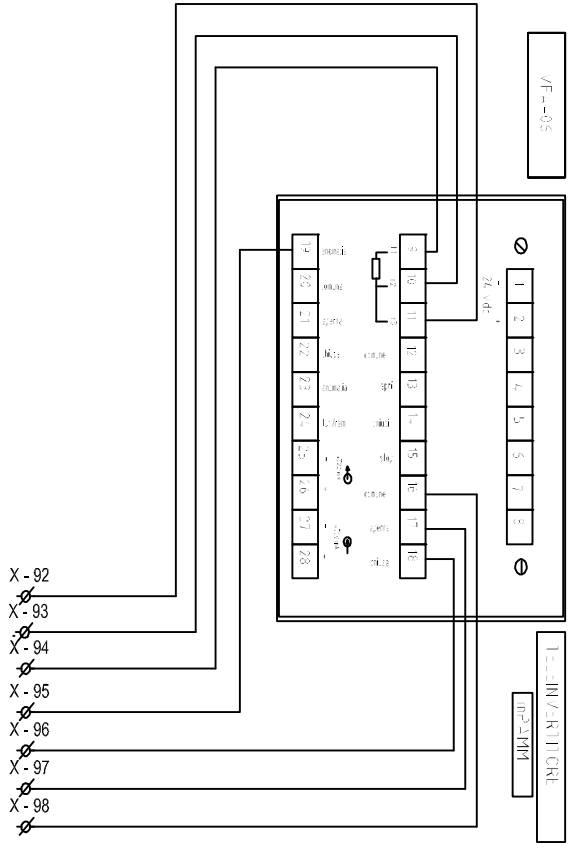
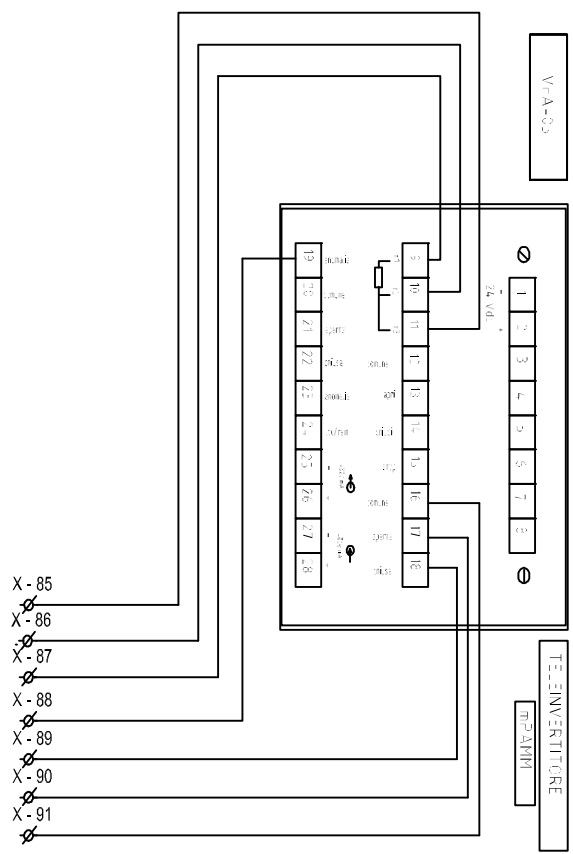

REVISIONE	MODIFICA	PROGETTO: UNITA' PERIFERICA TIPO SERBATOIO		FOGLIO 10
		COMMESSA:		DI 35
DATA	FIRMA	CLIENTE:		
		TITOLO:		
		DIS:	DATA:	9 <> 11

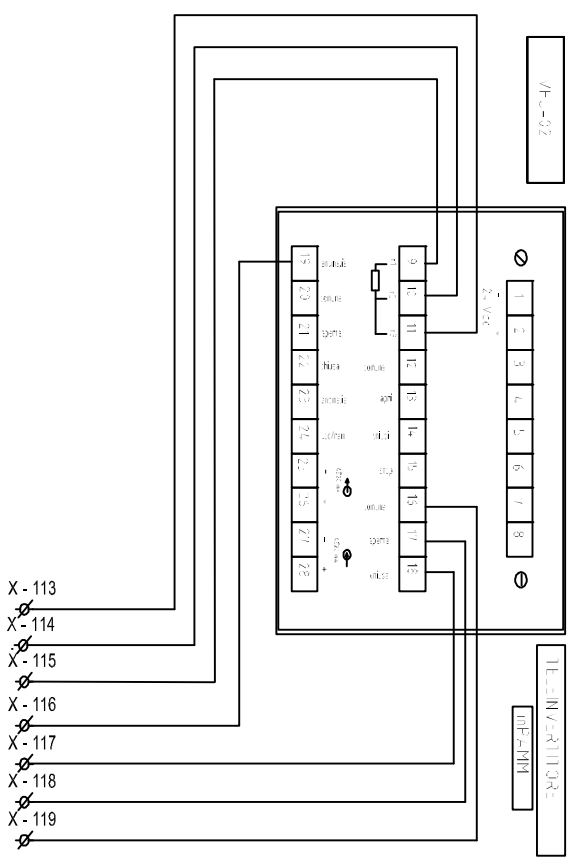

- X - 113
- X - 114
- X - 115
- X - 116
- X - 117
- X - 118
- X - 119

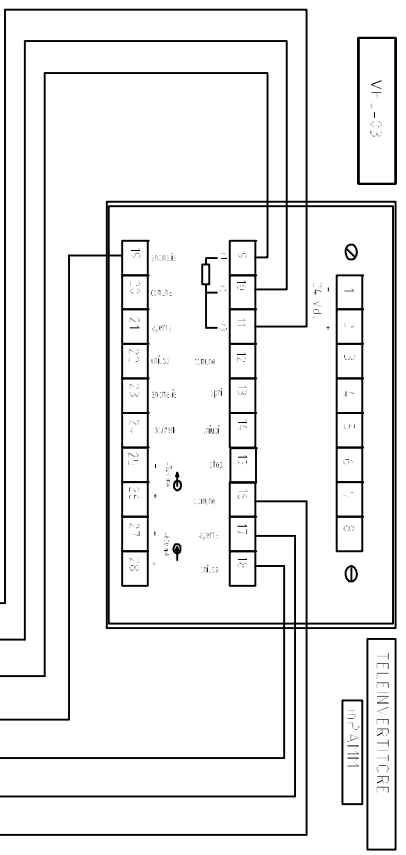

- X - 120
- X - 121
- X - 122
- X - 123
- X - 124
- X - 125
- X - 126

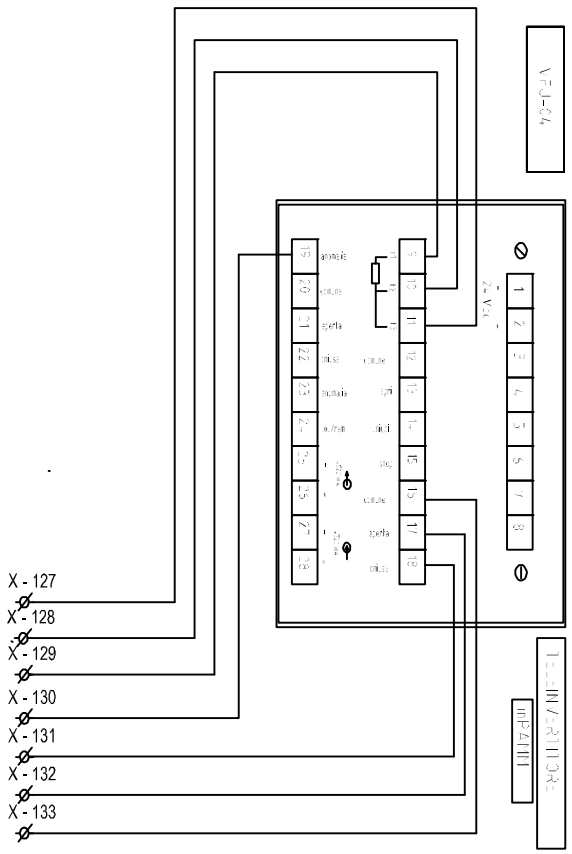

- X - 127
- X - 128
- X - 129
- X - 130
- X - 131
- X - 132
- X - 133

REVISIONE	MODIFICA	PROGETTO: UNITA' PERIFERICA TIPO SERBATOIO	FOGLIO 11
		COMMESSA:	DI 35
DATA	FIRMA	CLIENTE:	
		TITOLO:	
		DIS.:	DATA:
			10 < > 12

IN	OUT	PROBLEMA
13	4	1
14	5	1
15	6	1
16	7	1
17	8	1
18	9	1
19	10	1
20	11	1
21	12	1
22	13	1
23	14	1
24	15	1
25	16	1
26	17	1
27	18	1
28	19	1
29	20	1
30	21	1
31	22	1
32	23	1
33	24	1
34	25	1
35	26	1
36	27	1
37	28	1
38	29	1
39	30	1
40	31	1
41	32	1
42	33	1
43	34	1
44	35	1
45	36	1
46	37	1
47	38	1
48	39	1
49	40	1
50	41	1
51	42	1
52	43	1
53	44	1
54	45	1
55	46	1
56	47	1
57	48	1
58	49	1
59	50	1
60	51	1
61	52	1
62	53	1
63	54	1
64	55	1
65	56	1
66	57	1
67	58	1
68	59	1
69	60	1
70	61	1
71	62	1
72	63	1
73	64	1
74	65	1
75	66	1
76	67	1
77	68	1
78	69	1
79	70	1
80	71	1
81	72	1
82	73	1
83	74	1
84	75	1
85	76	1
86	77	1
87	78	1
88	79	1
89	80	1
90	81	1
91	82	1
92	83	1
93	84	1
94	85	1
95	86	1
96	87	1
97	88	1
98	89	1
99	90	1
100	91	1
101	92	1
102	93	1
103	94	1
104	95	1
105	96	1
106	97	1
107	98	1
108	99	1
109	100	1

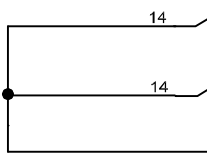
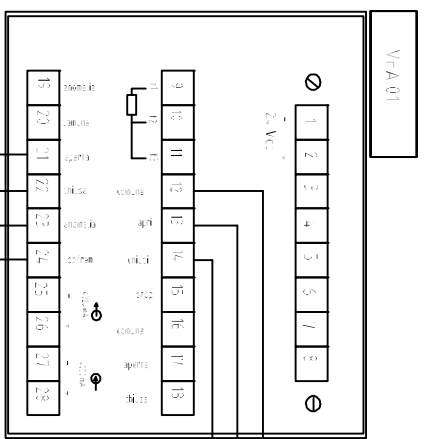
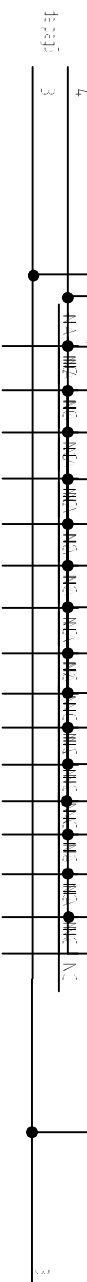

COM	18/23	=	INTELLIGENZA IN UNIBUS
COM	17/15	=	INTELLIGENZA IN UNIBUS

REVISIONE	MODIFICA
DATA	FIRMA

PROGETTO:	UNITA' PERIFERICA TIPO SERBATOIO
COMMESSA:	
CLIENTE:	
TITOLO:	
DIS.:	DATA:

NO	UNCL	PRELIEVO	POSIZIONE
17	-	-	1
18	3	-	1
19	9	-	1
110	10	-	1
LCM	11/12	-	1
LCM	35/36	-	1
LCM	37/38	-	1
LCM	39/40	-	2
LCM	41	-	2
LCM	42	-	2
LCM	43	-	2
LCM	44	-	2
LCM	45	-	2
LCM	46	-	2
LCM	47	-	2
LCM	48	-	2
LCM	49	-	2
LCM	50	-	2
LCM	51	-	2
LCM	52	-	2
LCM	53	-	2
LCM	54	-	2
LCM	55	-	2
LCM	56	-	2
LCM	57/58	-	2

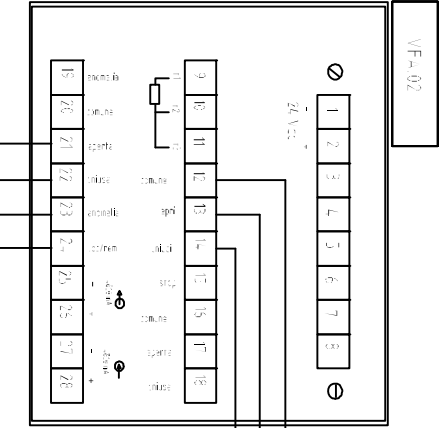
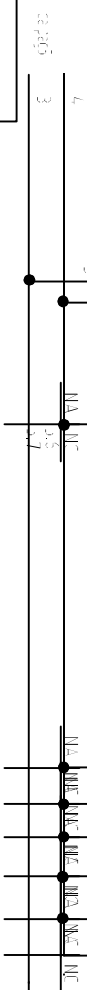

COM	18/78	REVISIONI DEL SISTEMA
COM	38/49	
COM	37/39	REVISIONI DEL SISTEMA

REVISIONE	MODIFICA	PROGETTO: UNITA' PERIFERICA TIPO SERBATOIO	FOGLIO 13
DATA	FIRMA	COMMESSA:	DI 35
		CIENTE:	
		TITOLO:	
		DIS.:	DATA:

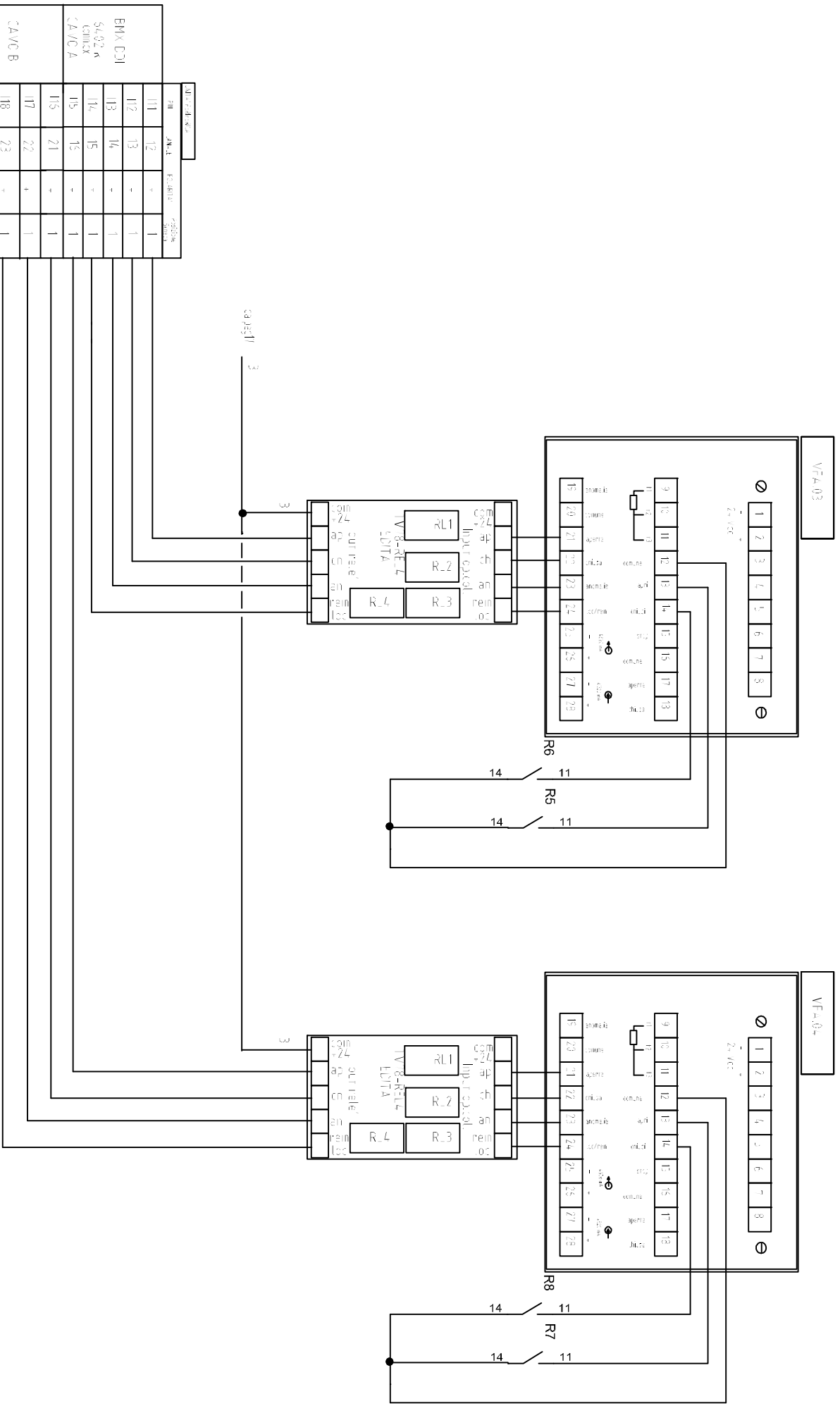

28	ANAL	ESABITA	PROBOK
I11	12	-	1
I12	13	-	1
I13	14	-	1
I14	15	-	1
I15	15	-	1
I16	21	-	1
I17	22	-	1
I18	23	-	1

EMX D31  
54.92 m  
COMICK  
CAVCA

CAVCA B

REVISIONE	MODIFICA	PROGETTO: UNITA PERIFERICA TIPO SERBATOIO	FOGLIO 14
		COMMESSA:	DI 35
DATA	FIRMA	CLIENTE:	
		TITOLO:	
		DIS.:	DATA:
			13 <> 15

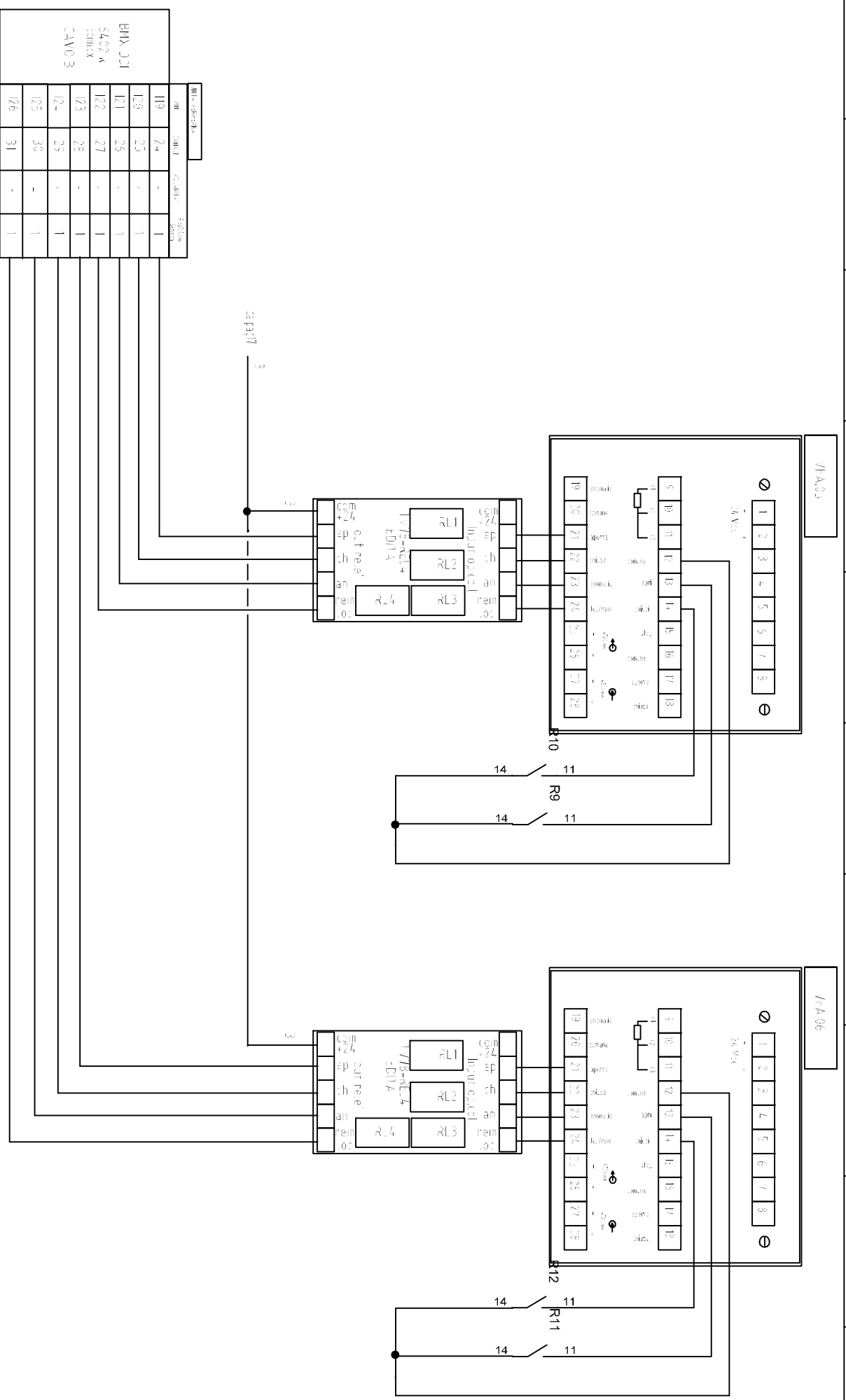

REVISIONE		MODIFICA	
DATA		FIRMA	
PROGETTO: UNITA' PERIFERICA TIPO SERBATOIO COMMESSA: CLIENTE: TITOLO: DIS.:			
		FOGLIO 15	
		DI 35	
		14 <> 16	



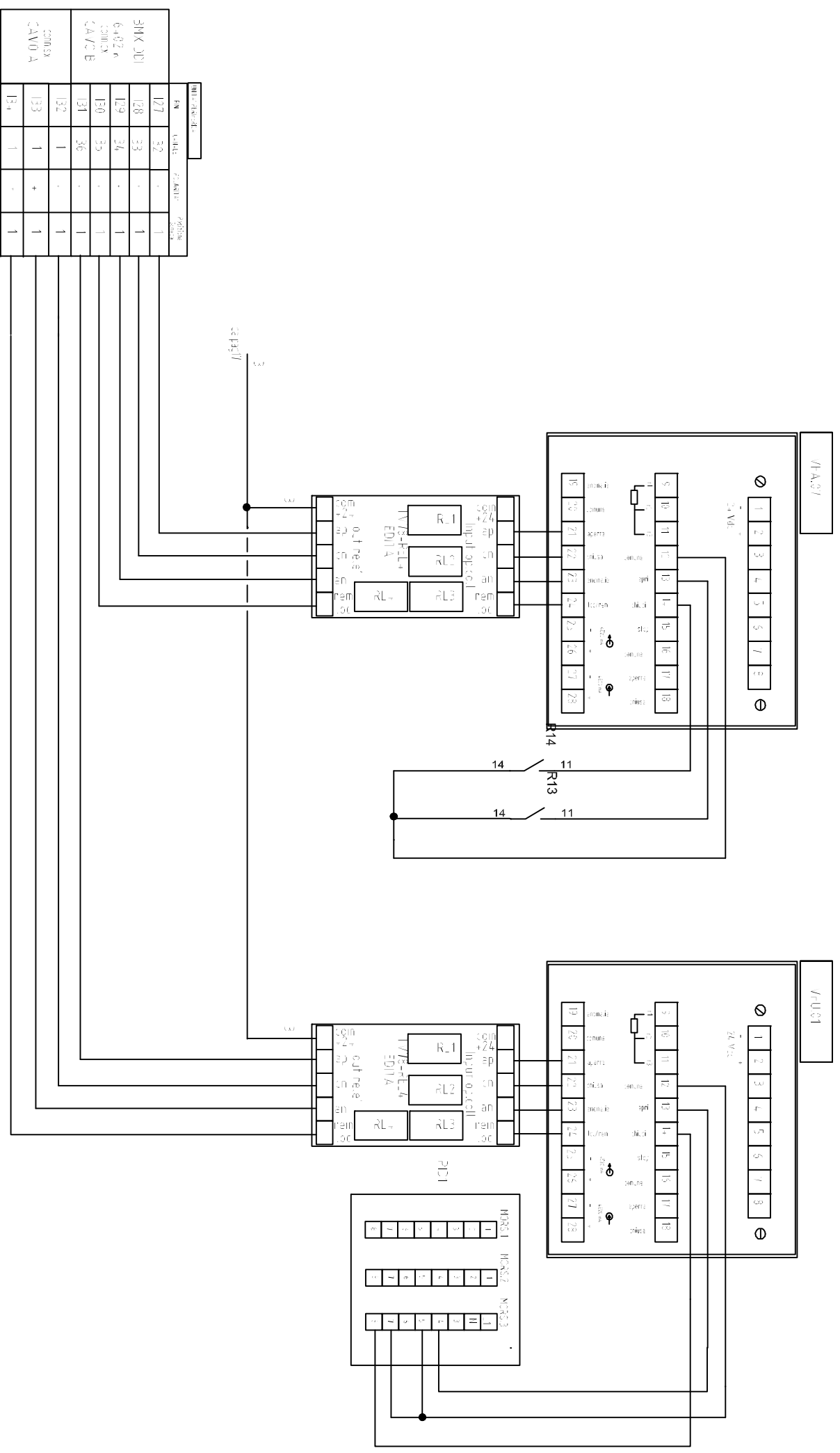

REVISIONE		MODIFICA		PROGETTO: UNITA' PERIFERICA TIPO SERBATOIO		FOGLIO 16	
DATA		FIRMA		COMMESSA:		DI 35	
				CLIENTE:			
				TITOLO:			
				DIS.:		DATA:	
						15 <> 17	

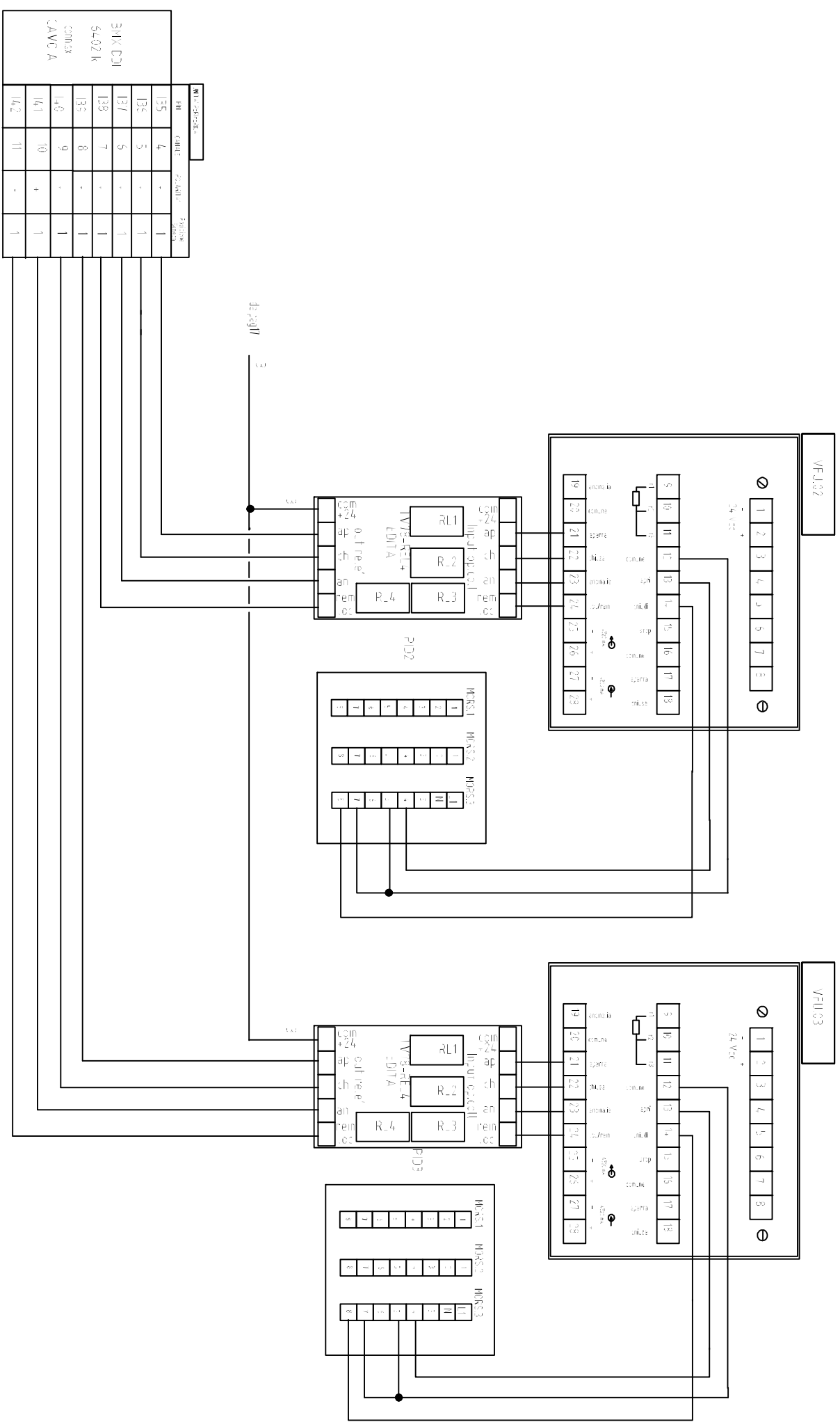

Modificata-	CHI	CAUSE	RELAZIO	REVISIONE
135	4	-	-	1
134	5	-	-	1
137	5	-	-	1
138	7	-	-	1
135	8	-	-	1
140	9	-	-	1
141	10	-	-	1
142	11	-	-	1

3HX/CDI  
54-02 K  
COMO SX  
CAVCA A

REVISIONE	MODIFICA	PROGETTO: UNITA' PERIFERICA TIPO SERBATOIO	FOGLIO 17
		COMMESSA:	DI 35
		CLIENTE:	
		TITOLO:	
DATA	FIRMA	DIS.:	DATA:
			16 < > 18

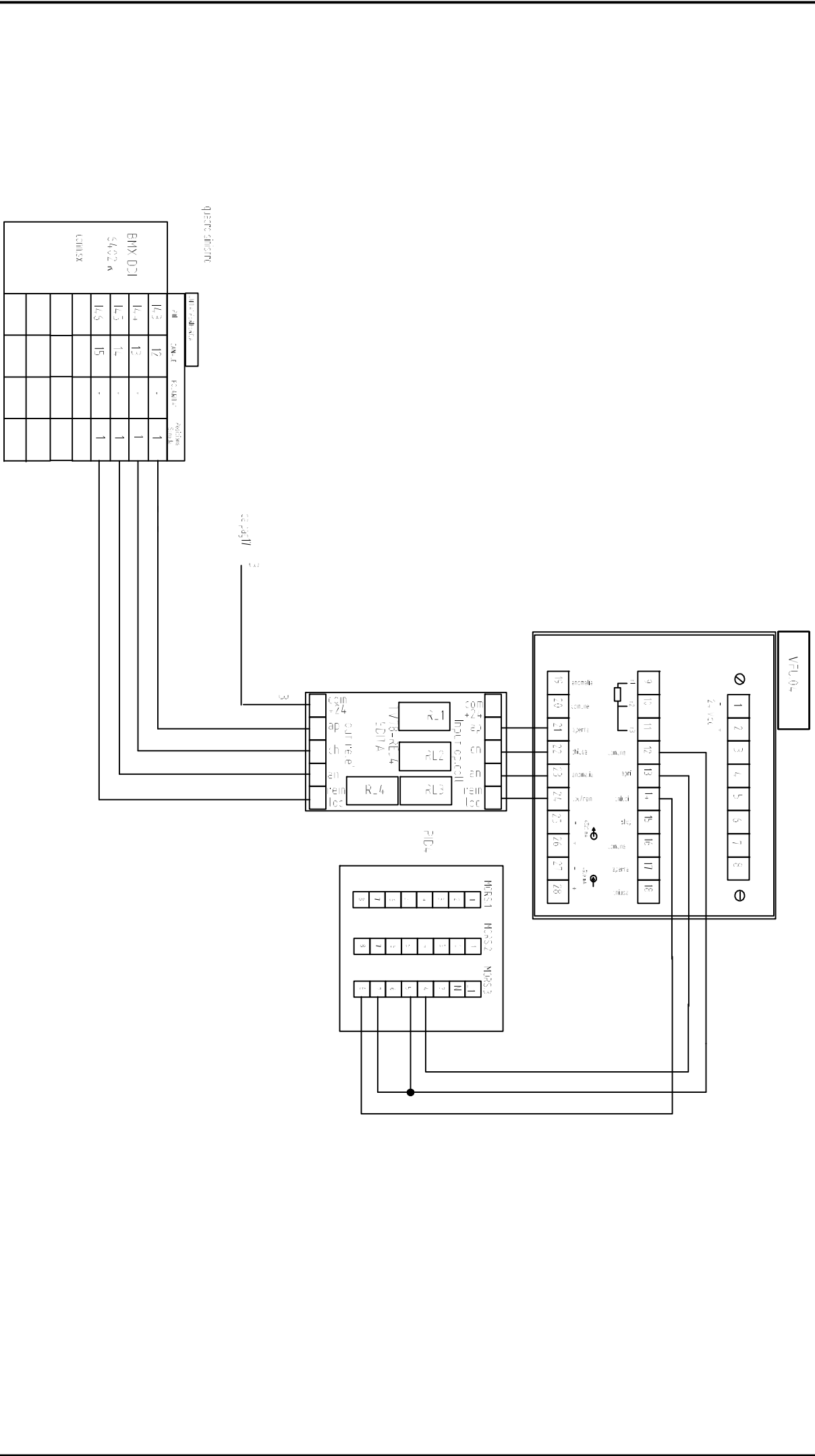

REVISIONE	MODIFICA	PROGETTO: UNITA' PERIFERICA TIPO SERBATOIO	FOGLIO 18
		COMMESSA:	DI 35
DATA	FIRMA	CLIENTE:	
		TITOLO:	
		DIS.:	DATA:
			17 <> 19

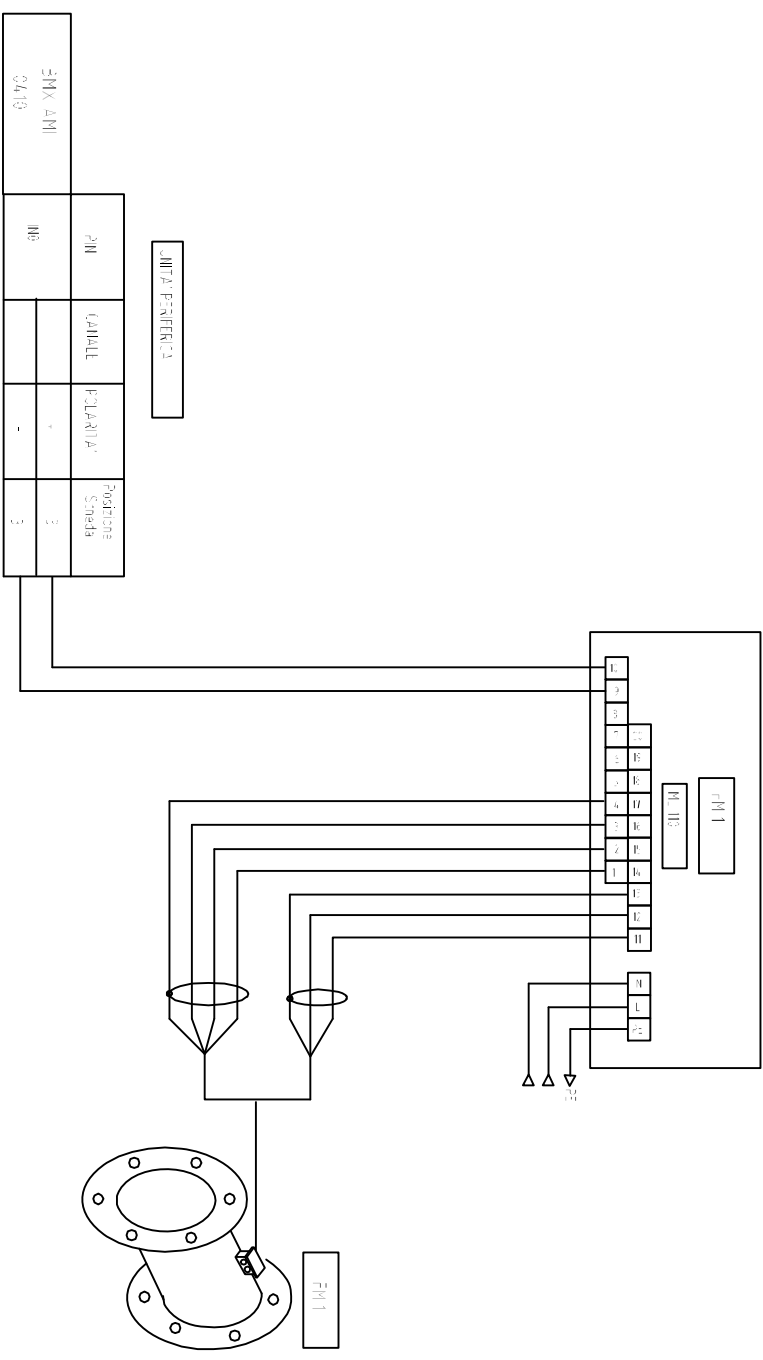

SMX AMI 0419	NO	CAVILL	FLUORIA	Protezione Scheda
-----------------	----	--------	---------	----------------------

REVISIONE	MODIFICA	PROGETTO: UNITA PERIFERICA TIPO SERBATOIO	FOGLIO 19
		COMMESSA:	DI 35
		CLIENTE:	
		TITOLO:	
DATA	FIRMA	DIS.:	DATA:
			18 <> 20

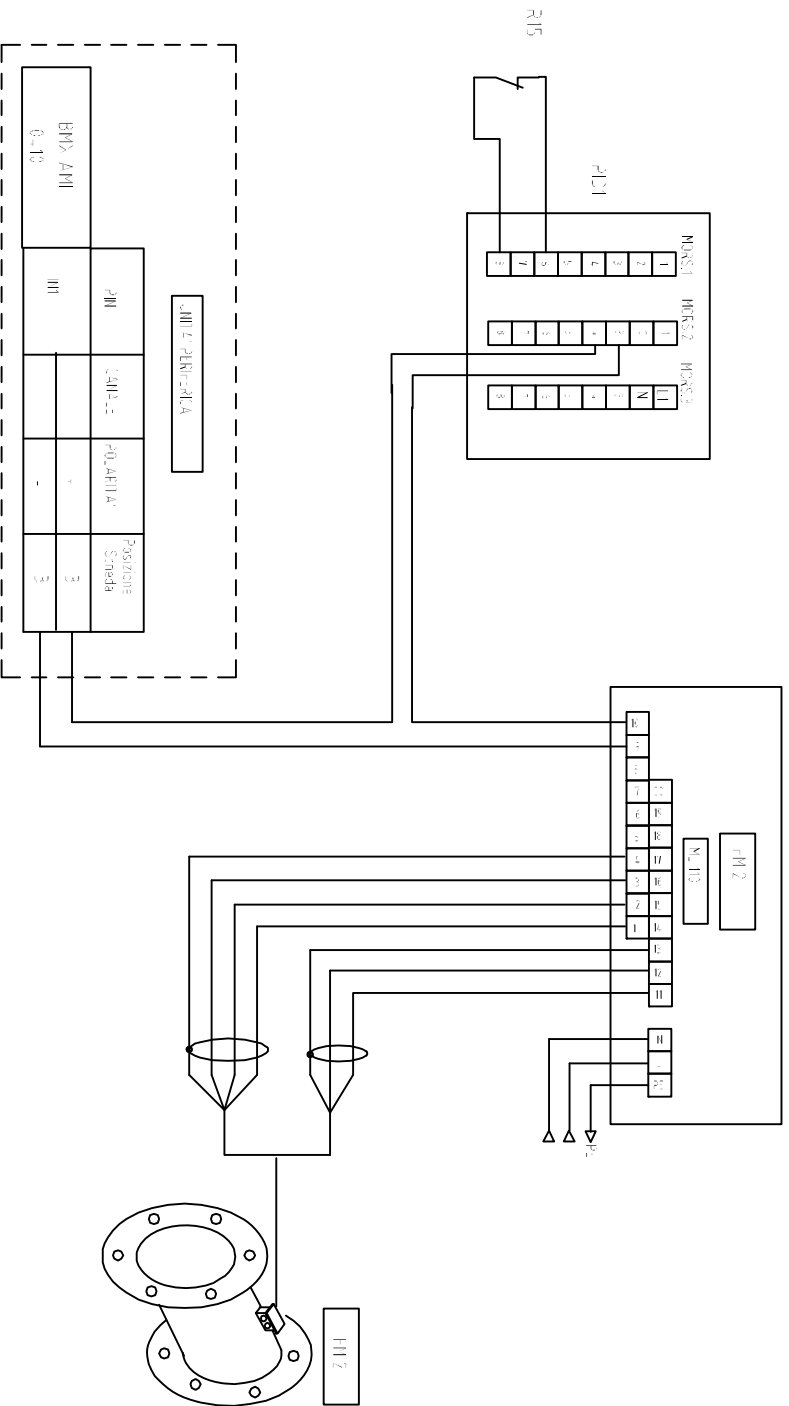

UNITA' PERIFERICA			
ARM. AMM	ARM	QUANTITA'	POSIZIONE
0-10	001	1	3

REVISIONE	MODIFICA	PROGETTO: UNITA' PERIFERICA TIPO SERBATOIO	FOGLIO 20
		COMMESSA:	DI 35
		CIENTE:	
		TITOLO:	
DATA	FIRMA	DIS.:	DATA:
			19 <math>\Delta</math> 21

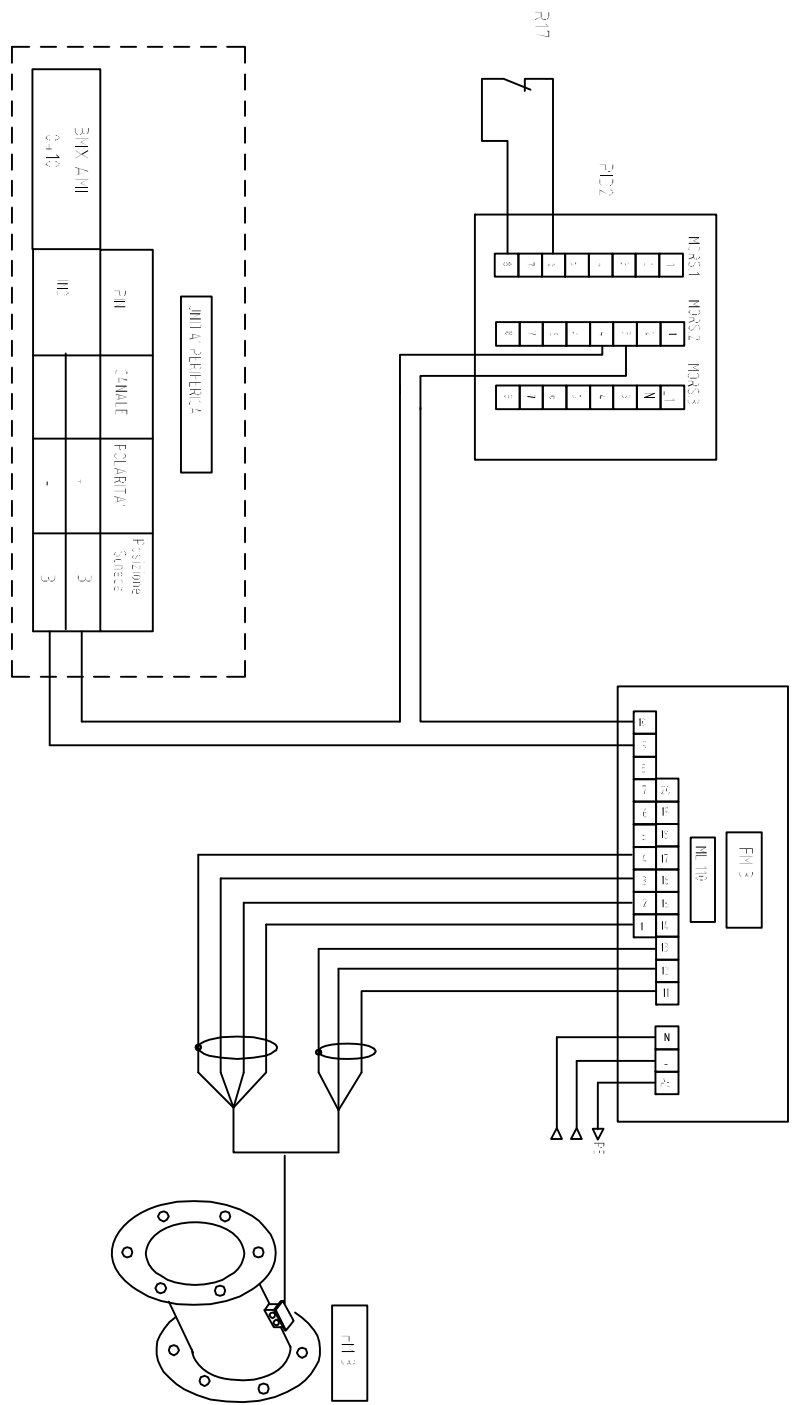

REVISIONE	MODIFICA	PROGETTO: UNITA' PERIFERICA TIPO SERBATOIO	FOGLIO 21
		COMMESSA:	DI 35
DATA	FIRMA	TITOLO:	
		DIS.:	DATA:
			20 <math>\leftrightarrow</math> 22

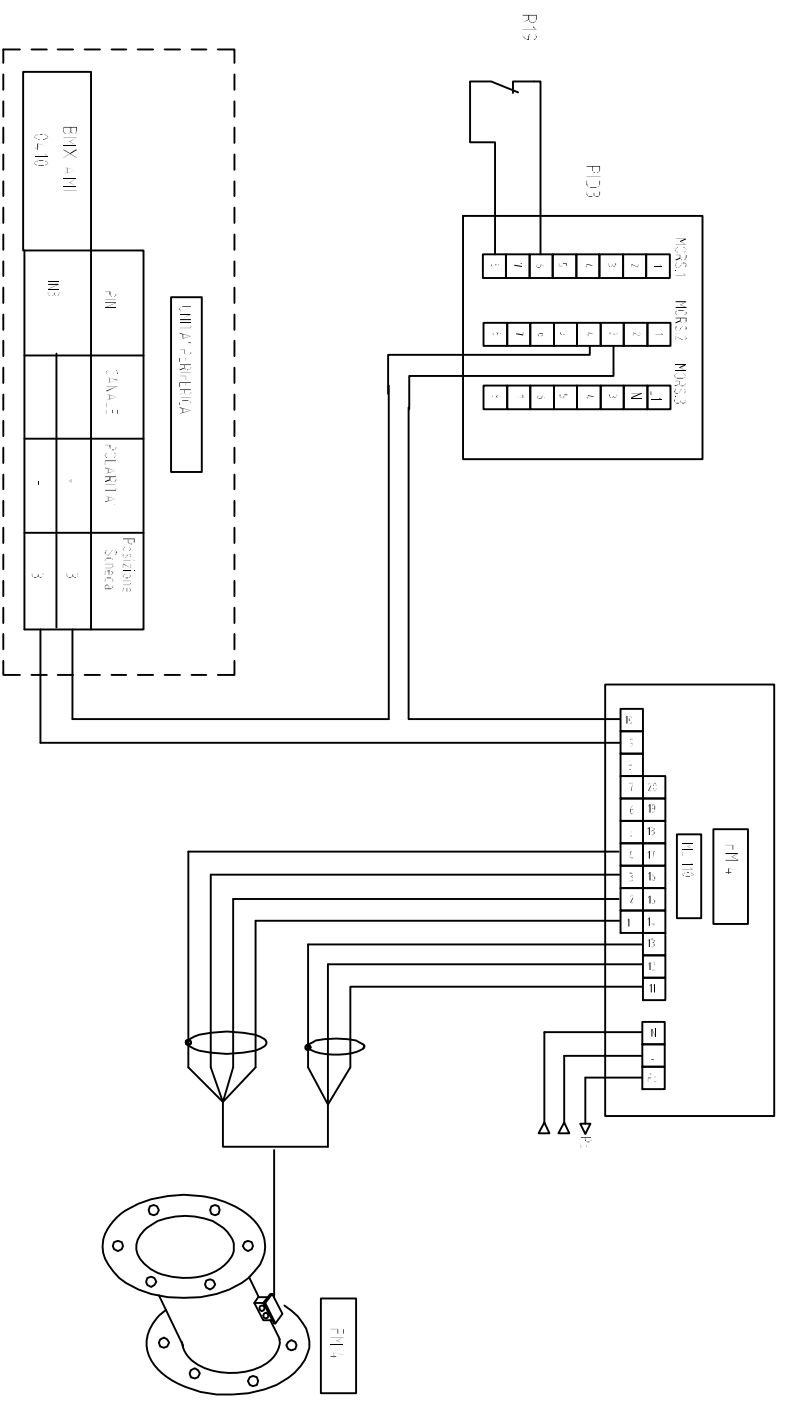

UNITA' PERIFERICA			
BHX - III	PHI	CANALE	Posizione Sopra
0-10	III	PCUARIA	3

REVISIONE	MODIFICA	PROGETTO: UNITA' PERIFERICA TIPO SERBATOIO	FOGLIO 22
DATA	FIRMA	COMMESSA:	DI 35
		CLIENTE:	
		TITOLO:	
		DIS.:	DATA:
			21 <> 23

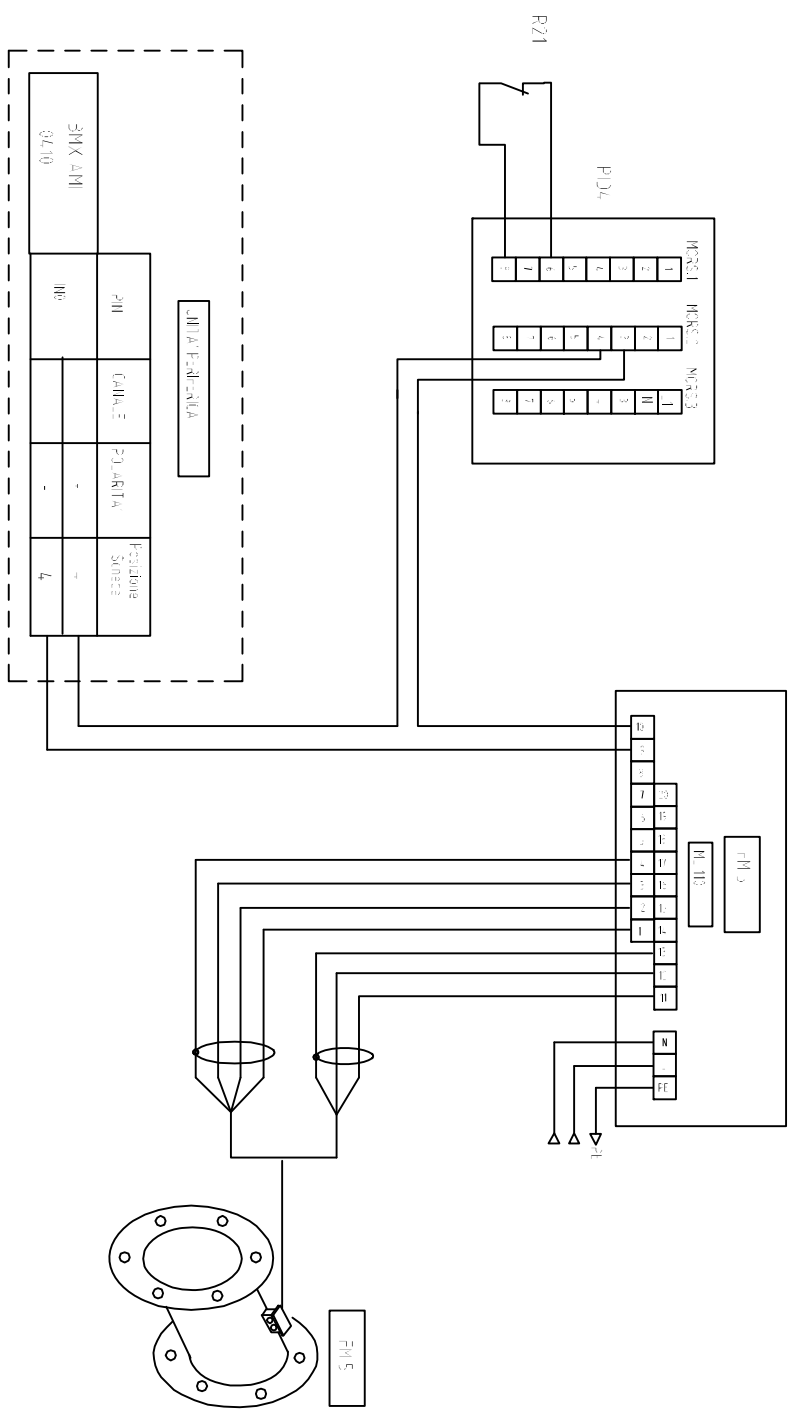

REVISIONE	MODIFICA
DATA	FIRMA

PROGETTO: UNITA' PERIFERICA TIPO SERBATOIO	FOGLIO 23
COMMESSA:	DI 35
CLIENTE:	
TITOLO:	
DIS.:	DATA:
	22 <math>\leftrightarrow</math> 24



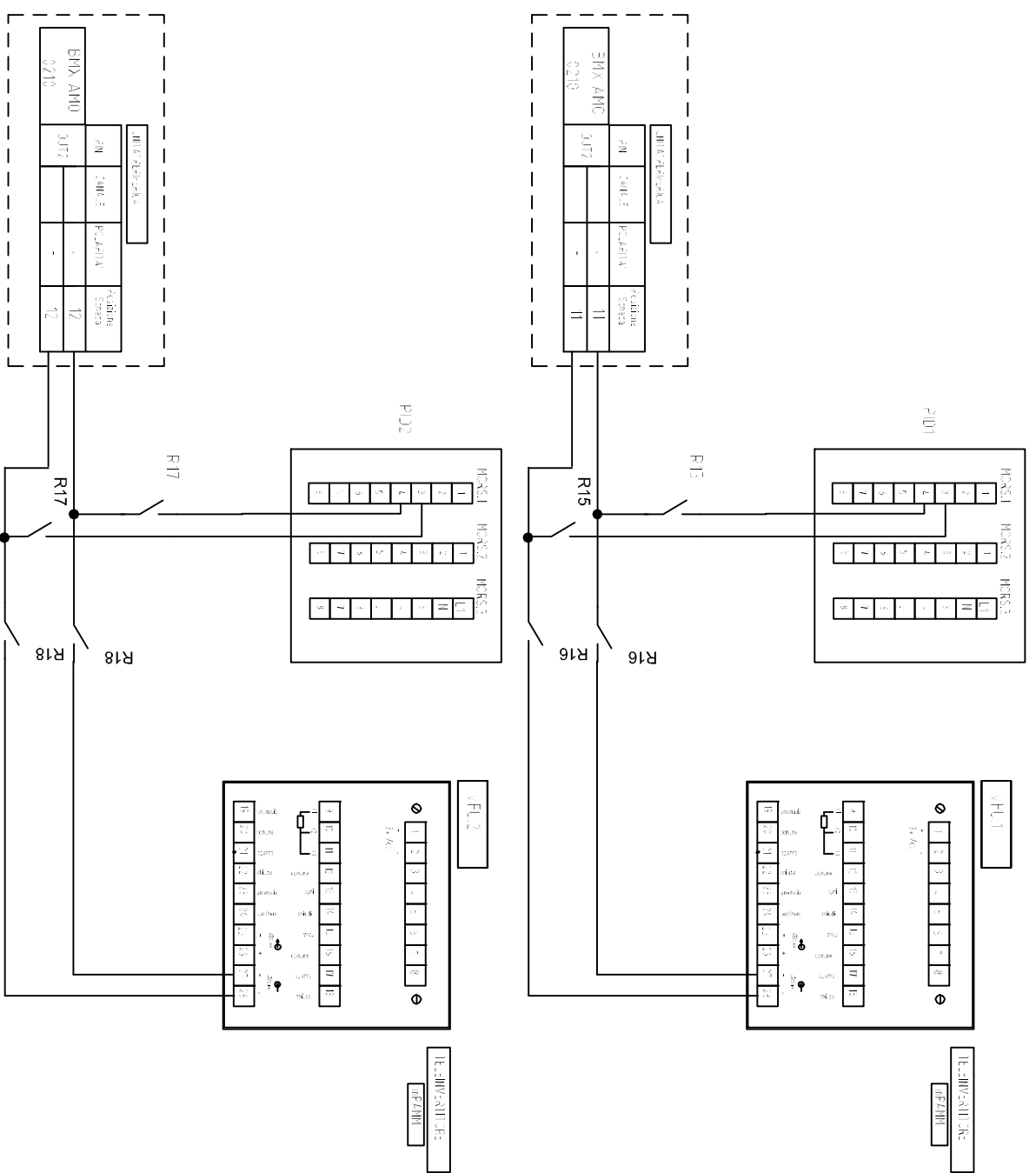

MORSE			
AM	SOLE	PERMAN	Protezione Sensore
BMX AMO 0210	JUTZ	-	12 12

MORSE			
AM	SOLE	PERMAN	Protezione Sensore
BMX AMO 0210	JUTZ	-	11 11

REVISIONE	MODIFICA
DATA	FIRMA

PROGETTO: UNITA' PERIFERICA TIPO SERBATOIO
COMMESSA:
CLIENTE:
TITOLO:
DIS:

FOGLIO 24
DI 35
23 < > 25

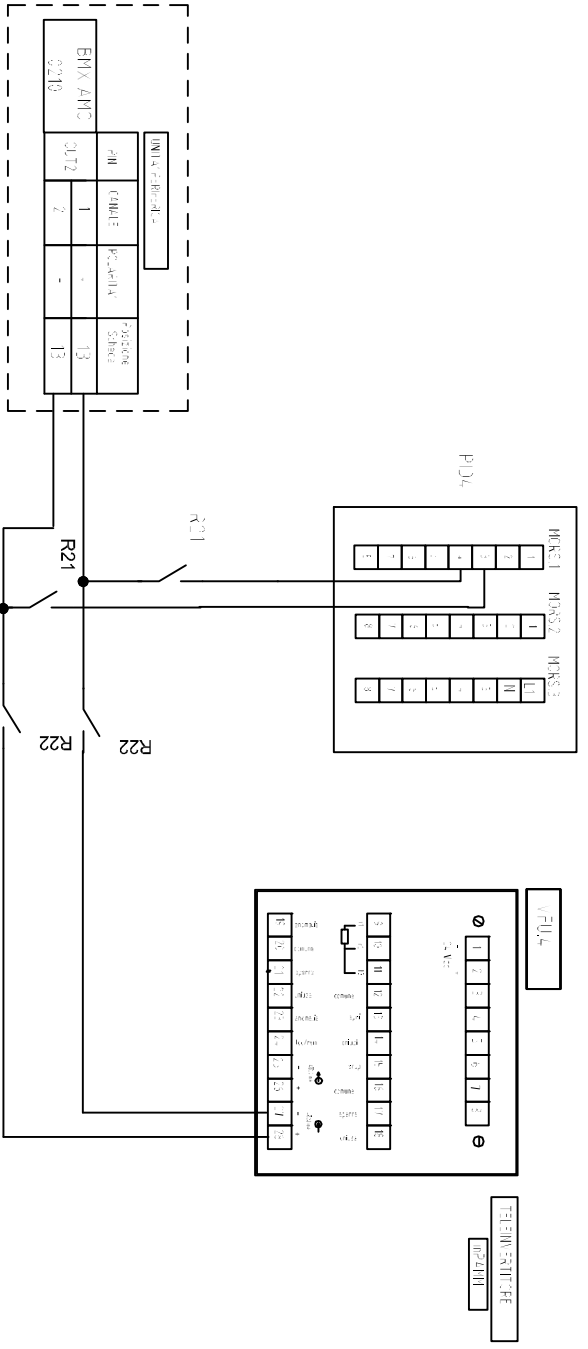
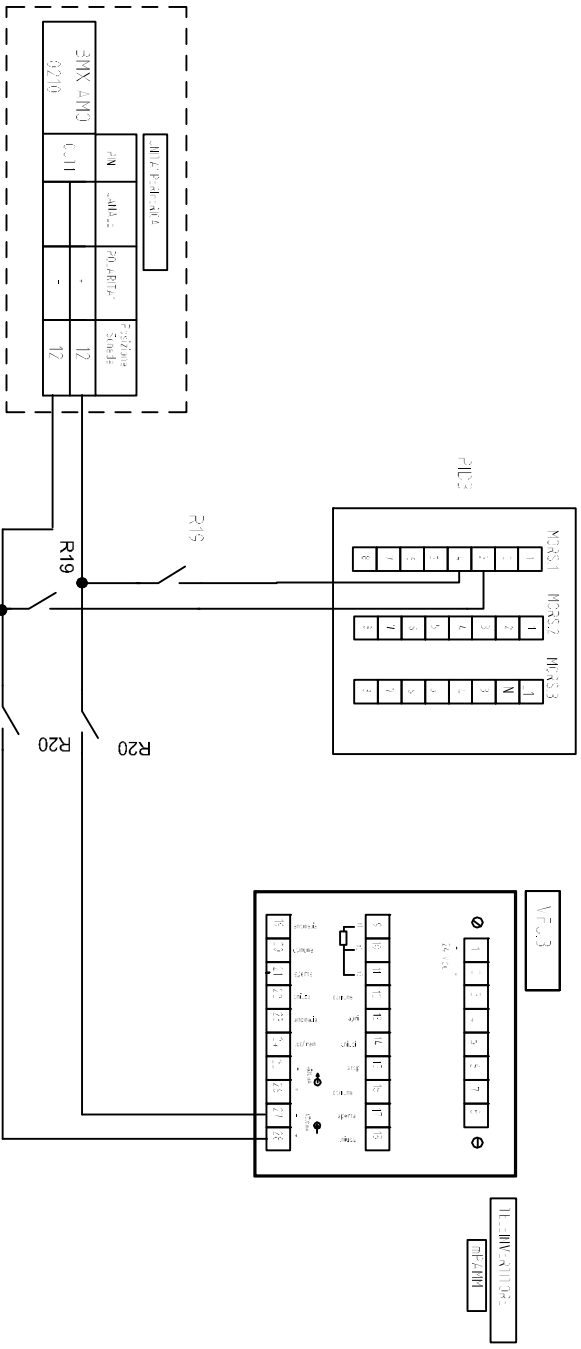

UNITA' CONTROLLO			
PROG.	CELLA	RELAJA	POSIZIONE SPINCE
BHX/AMS	1	-	13
0210	2	-	13

UNITA' CONTROLLO			
PROG.	CELLA	RELAJA	POSIZIONE SPINCE
BHX/AMS	1	-	12
0210	2	-	12

REVISIONE	MODIFICA	PROGETTO: UNITA' PERIFERICA TIPO SERBATOIO	FOGLIO 25
		COMMESSA:	DI 35
		CLIENTE:	
		TITOLO:	
DATA	FIRMA	DIS.:	DATA:

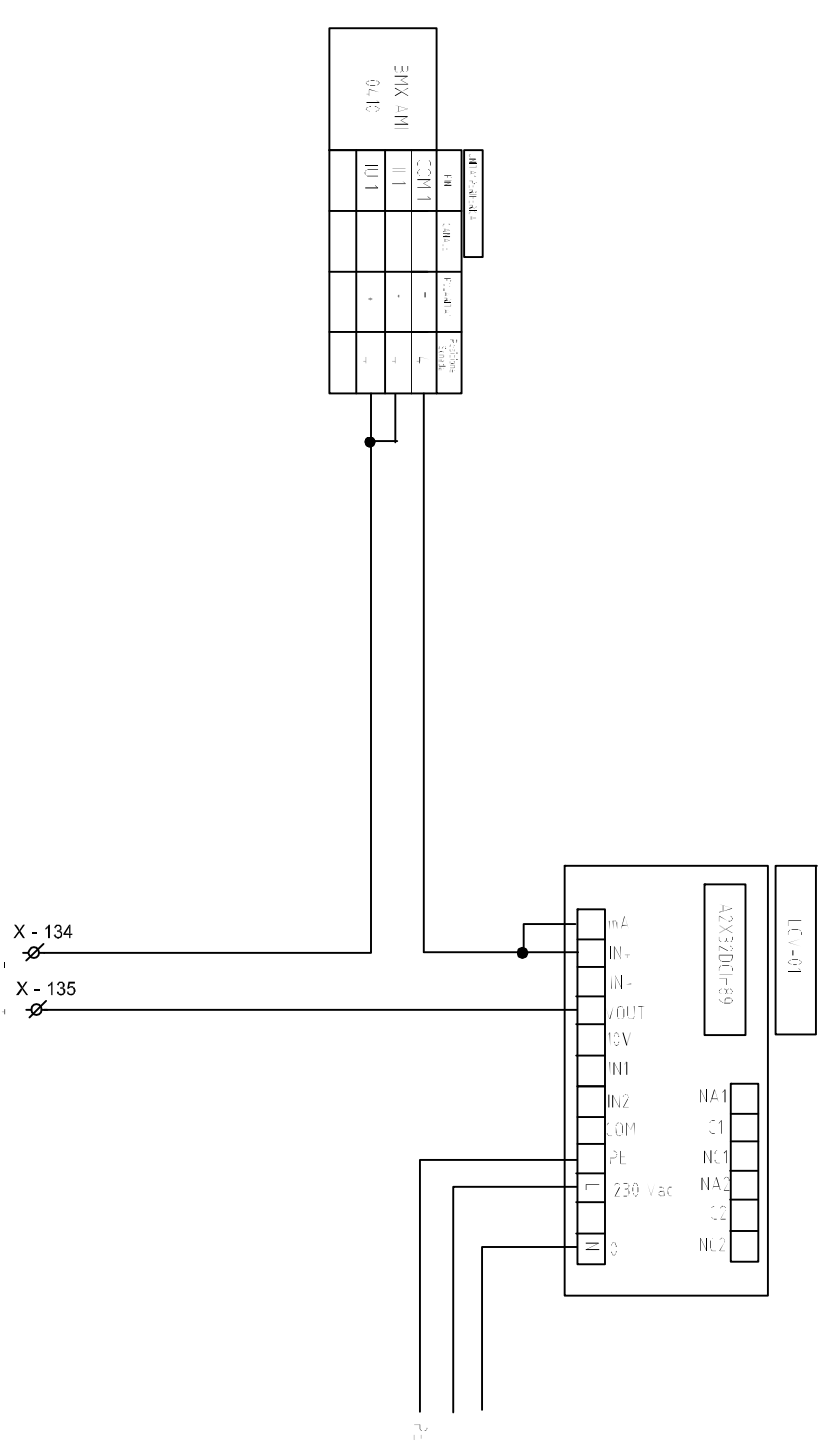

REVISIONE	MODIFICA	PROGETTO: UNITA' PERIFERICA TIPO SERBATOIO	FOGLIO 26
		COMMESSA:	DI 35
DATA	FIRMA	CLIENTE:	
		TITOLO:	
		DIS.:	DATA:
			25 <> 27

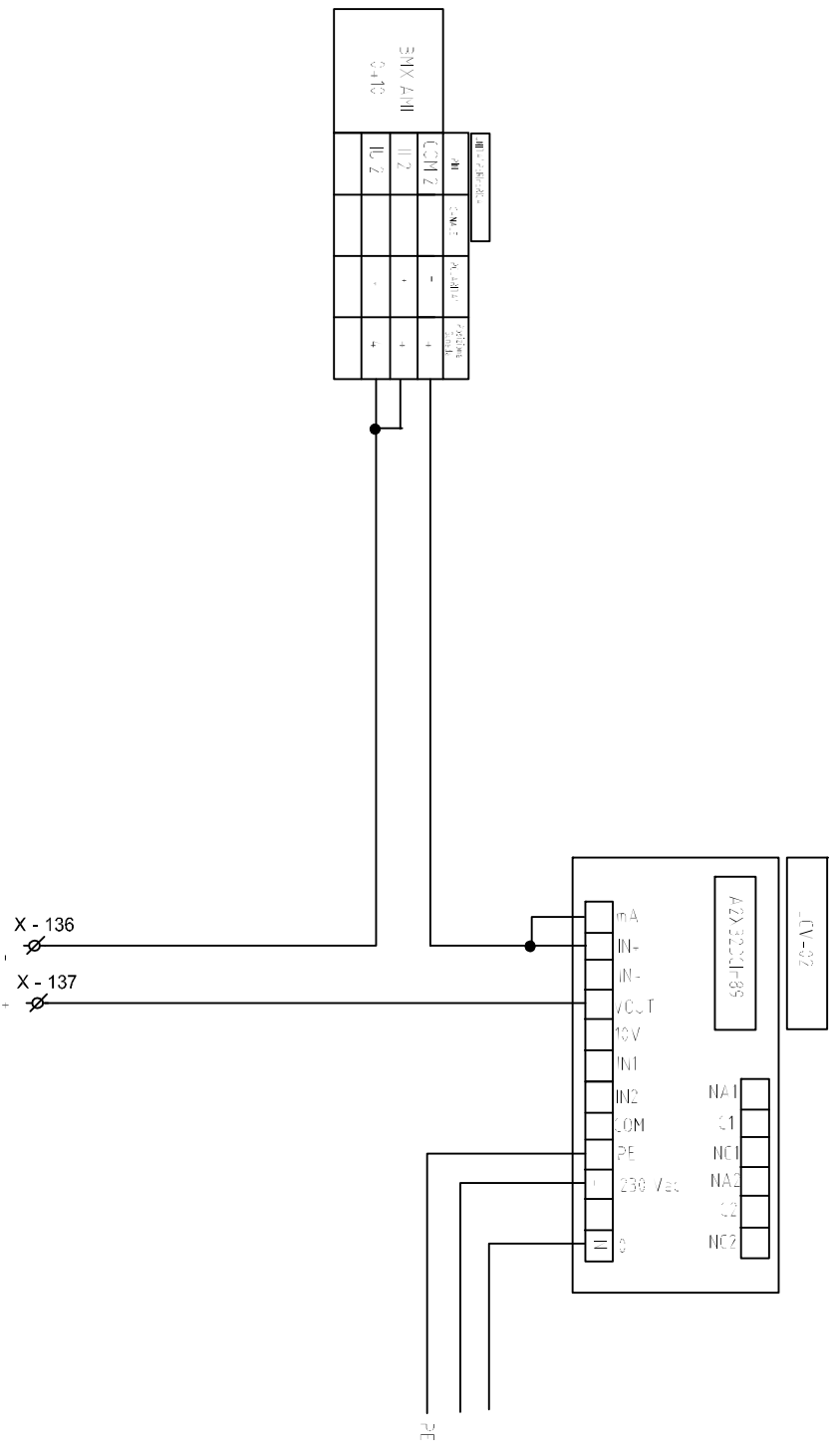

MATERIE PRIME			
MR	CANT.	UNITA' DI MISURA	REVISIONE
COM 2	-	+	+
IN 2	+	+	+
IN 2	-	+	+

REVISIONE	MODIFICA	PROGETTO: UNITA' PERIFERICA TIPO SERBATOIO COMMESSA: CLIENTE: TITOLO: DIS.:	FOGLIO 27
			DI 35
DATA	FIRMA		26 < > 28

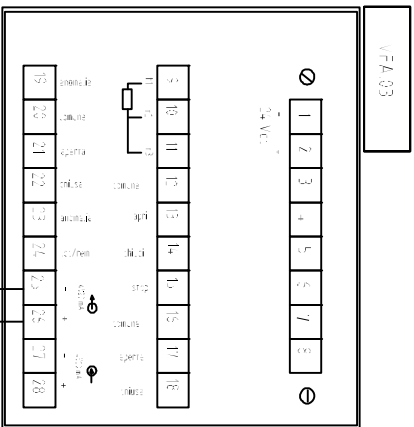
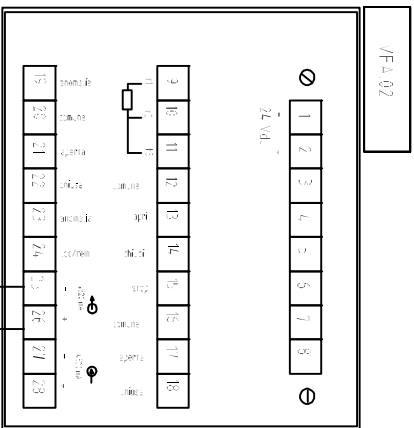
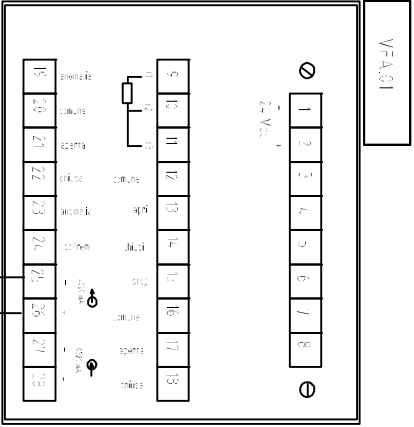

Intestazione	Pin	Can.	F.lettura	F.azione
COM 3	1	-	4	4
IL 3	2	-	4	4
IL 3	3	-	4	4
COM 3	4	-	3	3
COM 3	5	-	3	3
COM 3	6	-	3	3
COM 3	7	-	3	3
COM 3	8	-	3	3
COM 3	9	-	3	3
COM 3	10	-	3	3
COM 3	11	-	3	3
COM 3	12	-	3	3
COM 3	13	-	3	3
COM 3	14	-	3	3
COM 3	15	-	3	3
COM 3	16	-	3	3
COM 3	17	-	3	3
COM 3	18	-	3	3
COM 3	19	-	3	3
COM 3	20	-	3	3
COM 3	21	-	3	3
COM 3	22	-	3	3
COM 3	23	-	3	3
COM 3	24	-	3	3
COM 3	25	-	3	3
COM 3	26	-	3	3
COM 3	27	-	3	3
COM 3	28	-	3	3

REVISIONE	MODIFICA	PROGETTO: UNITA' PERIFERICA TIPO SERBATORIO	FOGLIO 28
		COMMESSA:	DI 35
		CLIENTE:	
		TITOLO:	
DATA	FIRMA	DIS.:	DATA:
			27 <> 29

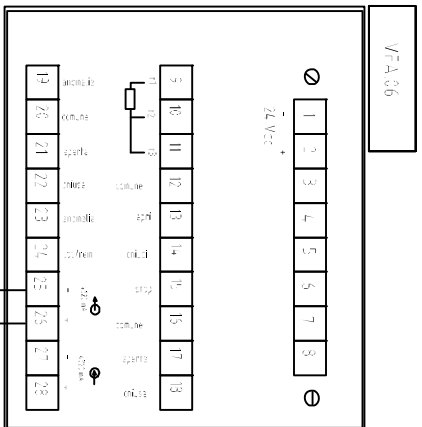
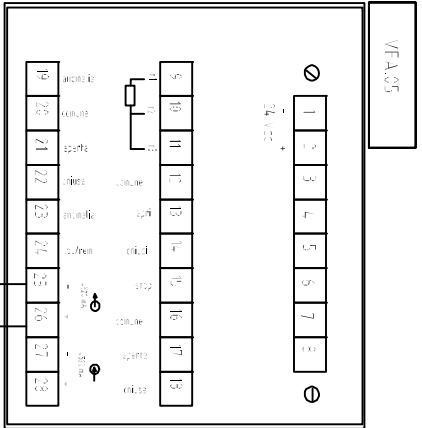
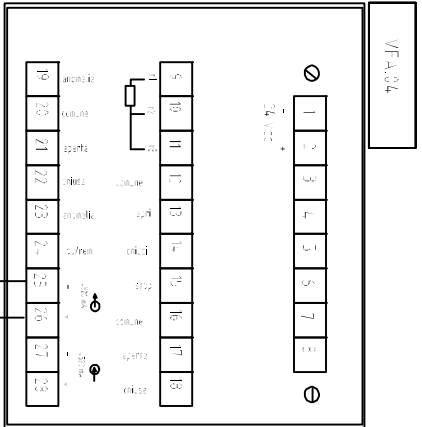

Alte. Seriale	Alte. Canale	Alte. Modulo	Alte. Posizione
COM 2	-	-	5
IL 2	-	-	5
IL 2	-	-	5
COM 3	-	-	5
IL 3	-	-	5
IL 3	-	-	5
COM 6	-	-	6
IL 6	-	-	6
IL 6	-	-	6

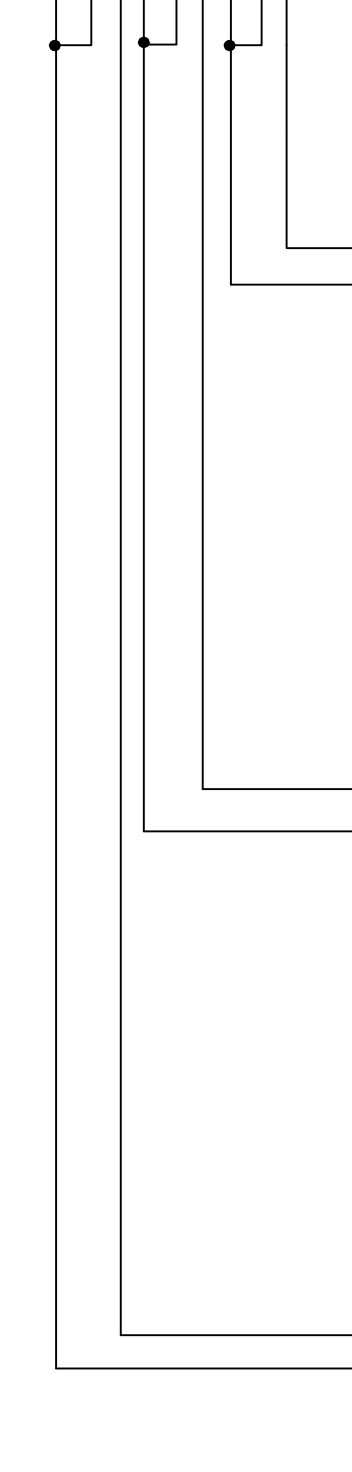

REVISIONE

MODIFICA

PROGETTO: UNITA' PERIFERICA TIPO SERBATOIO

FOGLIO 29

DATA

FIRMA

COMMESSA:

DI 35

DATA

FIRMA

CIENTE:

DIS: DATA:

DATA

FIRMA

DIS: DATA:

28 <|> 30

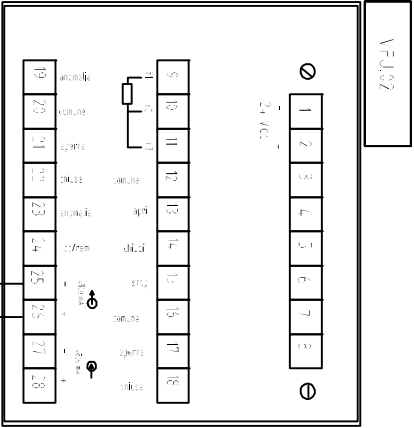
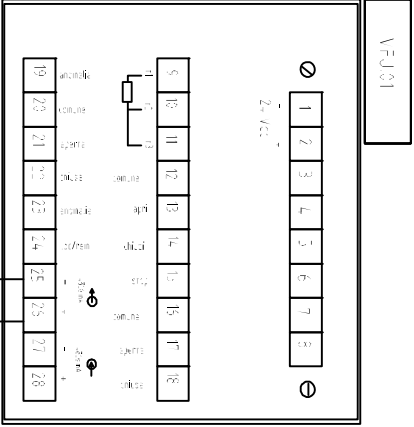
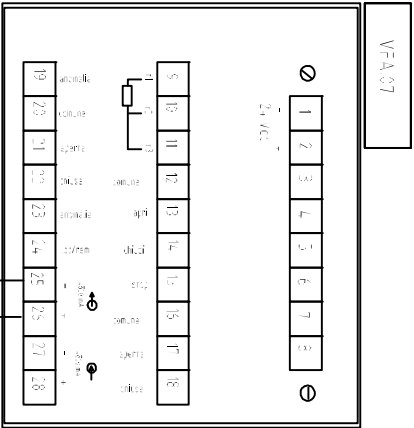

NUMERO	ANNO	REVISIONE
COM1	3	5
COM1	3	5
COM1	7	5
COM2	12	5
COM2	13	6
COM3	11	5
COM3	18	5
COM3	17	6
COM3	19	6

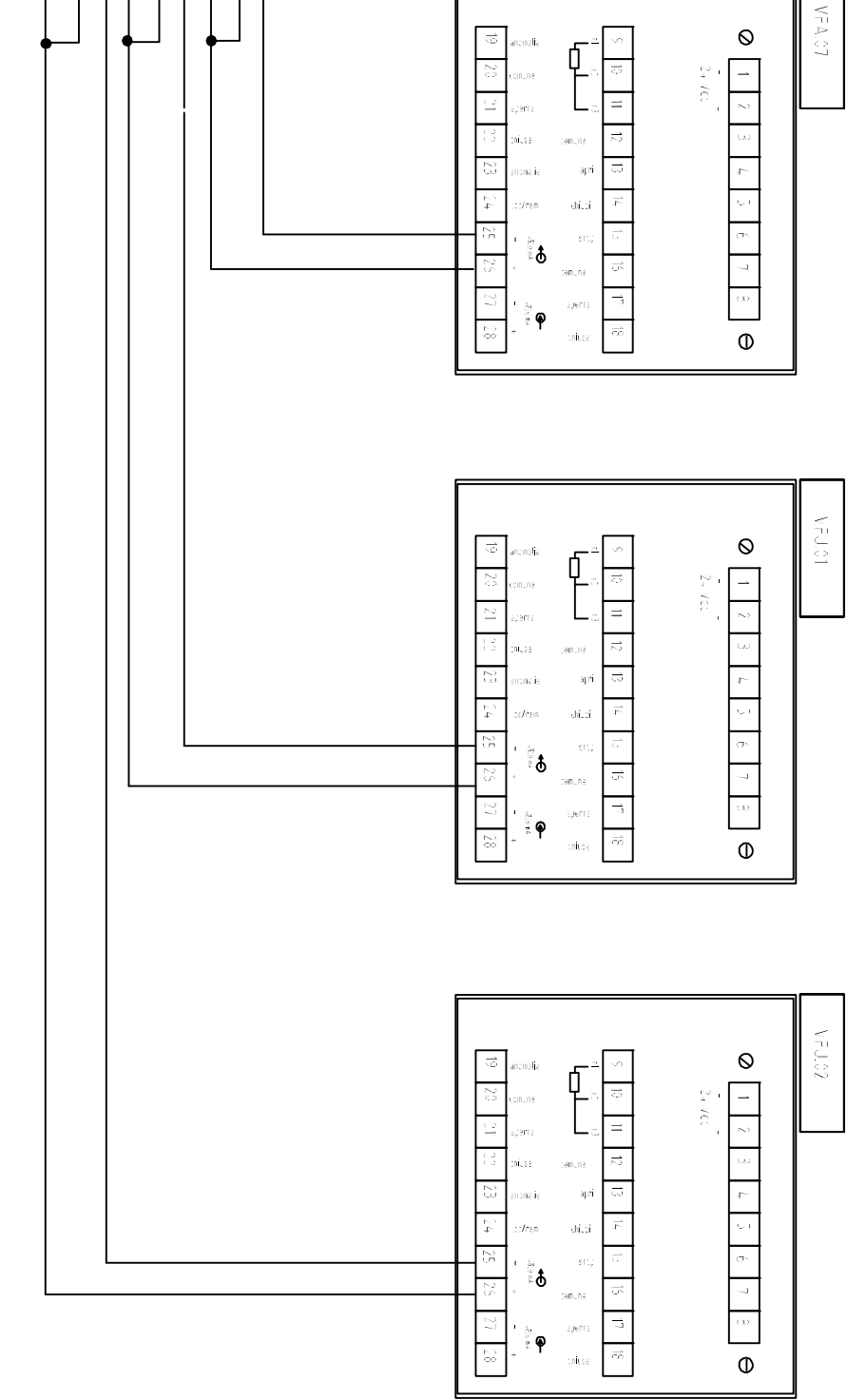

REVISIONE

MODIFICA

PROGETTO: UNITA' PERIFERICA TIPO SERBATOIO

COMMESSA:

FOGLIO 30

DATA

FIRMA

CLIENTE:

TITOLO:

DI 35

DIS.:

DATA:

DIS.:

DIS.:

29 <> 31

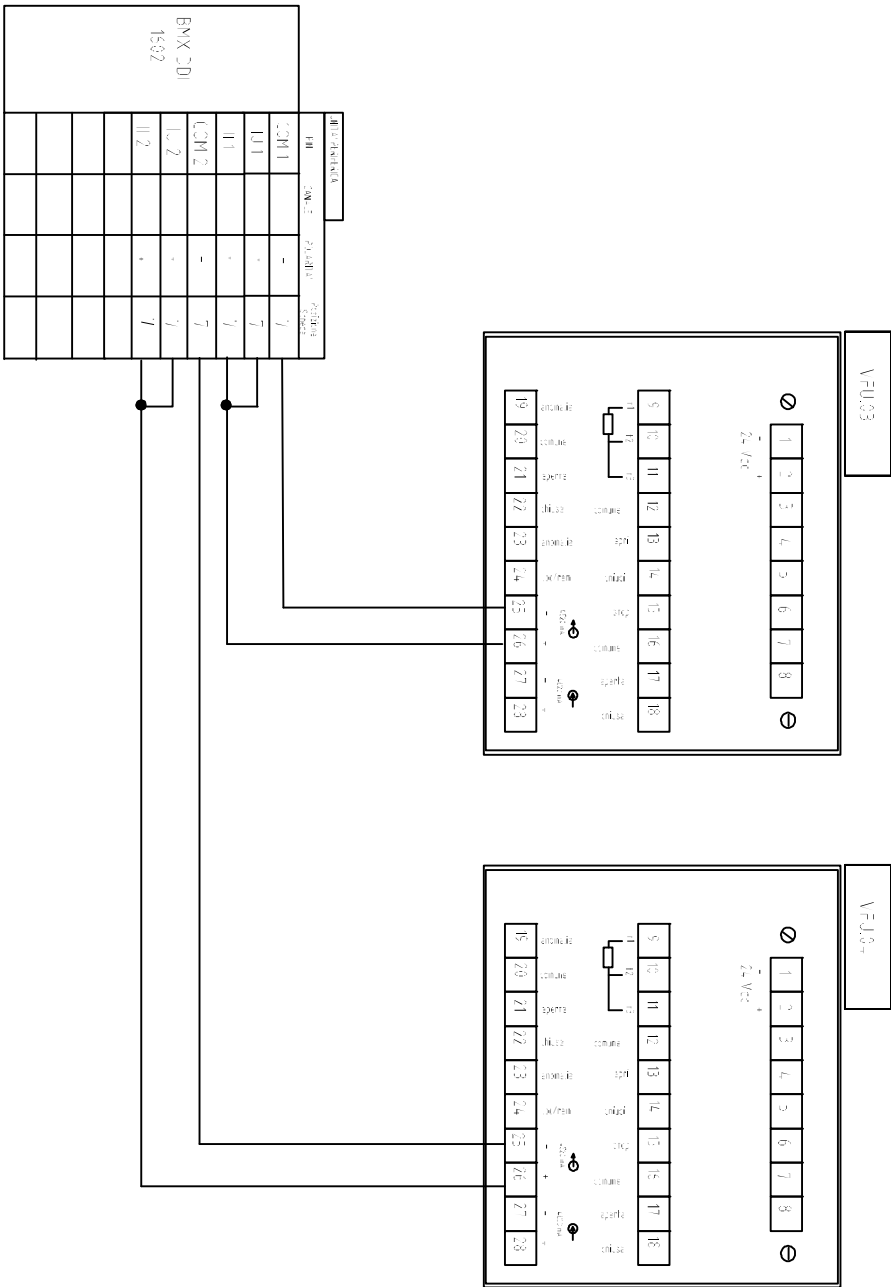

REVISIONE	MODIFICA	PROGETTO: UNITA' PERIFERICA TIPO SERBATOIO	FOGLIO 31
		COMMESSA:	DI 35
		CLIENTE:	
		TITOLO:	
DATA	FIRMA	DIS.:	DATA:
			30 ◀ ▶ 32



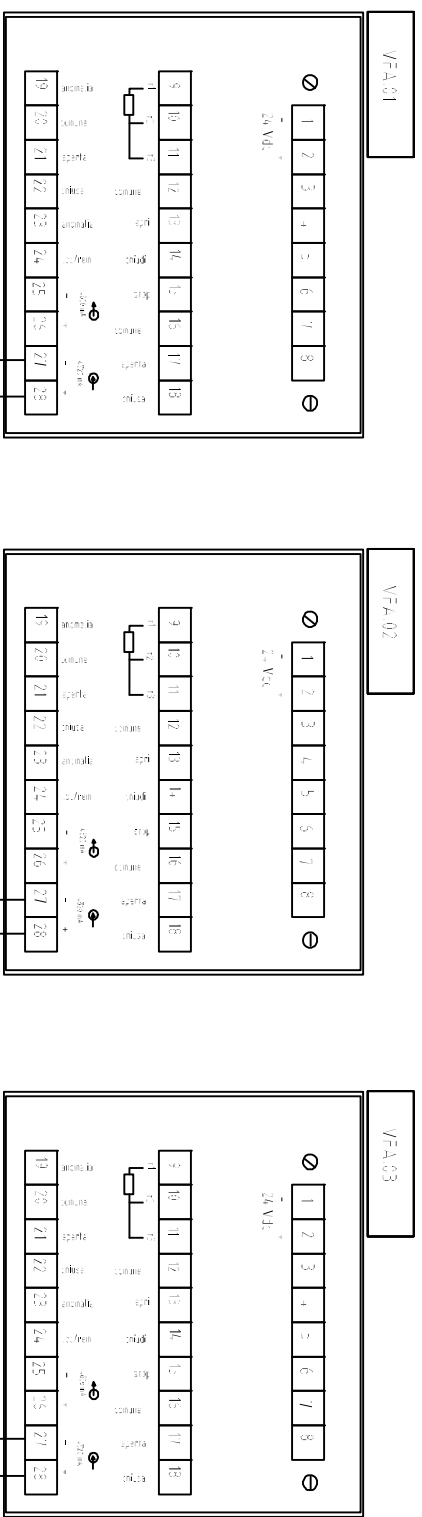

Modulo	Canale	Struttura	Posizione
EMX-AMC 0216	CM1	-	9
	CM11	-	9
	CM2	-	8
	CM12	-	8
	CM11	-	9
	CM11	-	9

REVISIONE	MODIFICA	PROGETTO: UNITA' PERIFERICA TIPO SERBATOIO	FOGLIO 32
		COMMESSA:	DI 35
DATA	FIRMA	CLIENTE:	
		TITOLO:	
		DIS.:	DATA:
			31 <> 33

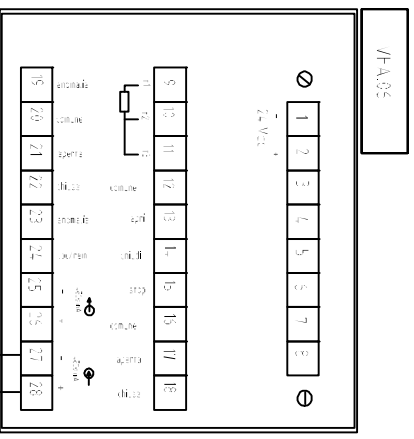
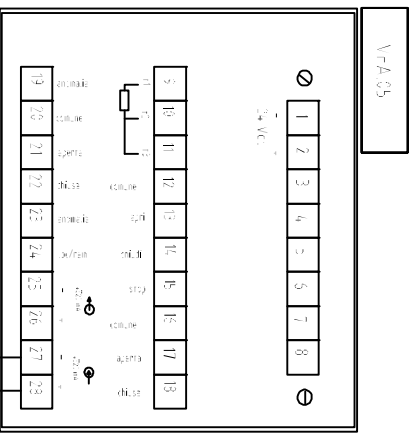
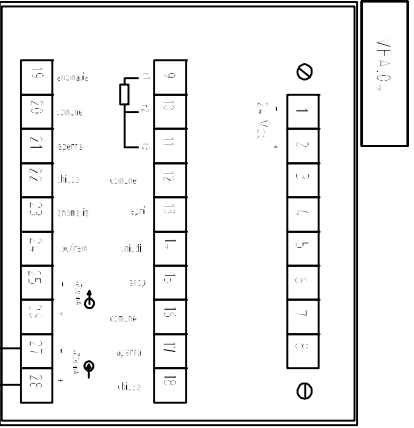

MATERIE			
QNT	DESCRIZIONE	UNITA'	PRODOTTORE
1	CON 2	-	9
1	CUT 2	-	9
1	CON 1	-	10
1	CUT 1	-	10
1	CON 2	-	10
1	CUT 2	-	10

REVISIONE	MODIFICA	PROGETTO: UNITA' PERIFERICA TIPO SERBATOIO	FOGLIO 33
		COMMESSA:	DI 35
		CLIENTE:	
		TITOLO:	
DATA	FIRMA	DIS.:	DATA:
			32 ◀ ▶ 34

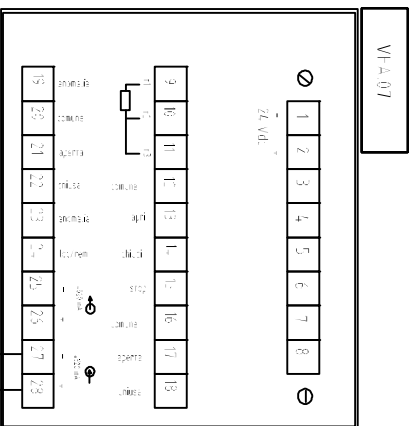

MATERIALE		
BI	CANT.	ESPOS.
COM1	-	11
SOTTI	-	11

3000 ANNO  
0218

REVISIONE	MODIFICA	PROGETTO: UNITA' PERIFERICA TIPO SERBATOIO	FOGLIO 34
DATA	FIRMA	COMMESSA:	DI 35
		CLIENTE:	DIS: 33 34 35
		TITOLO:	
		DIS: DATA:	

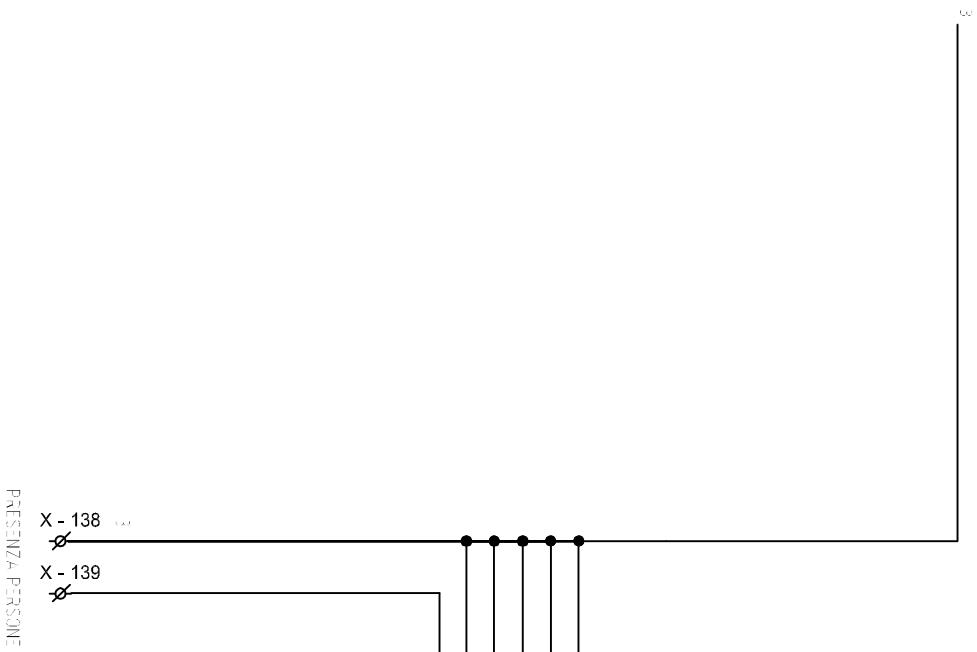

MATERIE:			
Q.TA.	UNITA'	Quantita'	Quantita' (MATERIE)
16-17-FM5		1	3MX DCI 5452 a
16-17-FM4		1	
16-17-FM3		1	
16-17-FM2		1	
16-17-FM1		1	
16		1	

REVISIONE	MODIFICA	PROGETTO: UNITA' PERIFERICA TIPO SERBATOIO	FOGLIO 35
DATA	FIRMA	COMMESSA:	DI 35
		CIENTE:	
		TITOLO:	
		DIS.:	DATA:
			34 <>